



おうちで、やろう。

Study at home. 小学校受験の家庭学習教材

言語：音の理解 12

それぞれの名前の初めの音が同じもの同士を線で結びます。



※1. このプリントは、しながわ・目黒こどもスクールのウェブサイトでダウンロードができます。無断複写・引用はご遠慮ください。
 ※2. このプリントを活用したオンライン授業のスケジュールは、しながわ・目黒こどもスクールのウェブサイトでご確認ください。



おうちで、やろう。

Study at home. 小学校受験の家庭学習教材

言語：数え方3

四角の中の2つの絵の数え方を考えます。数え方が同じときは○、数え方が違うときは×を真ん中の四角の中にかきます。

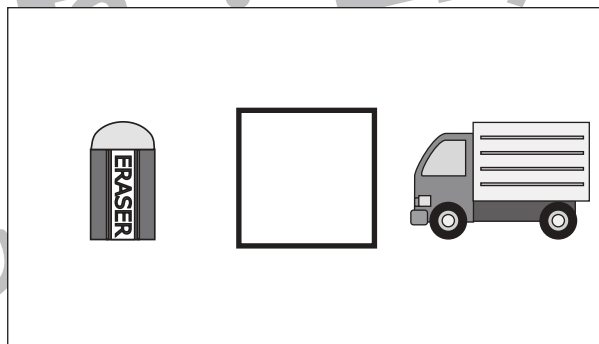
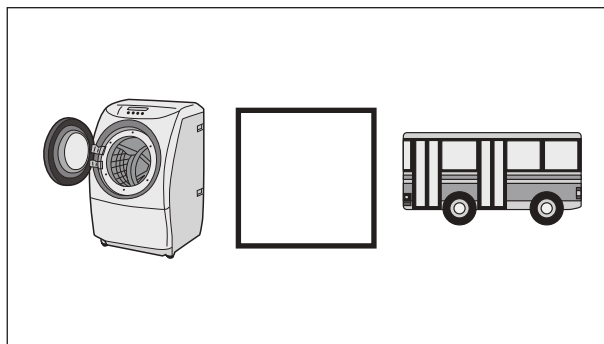
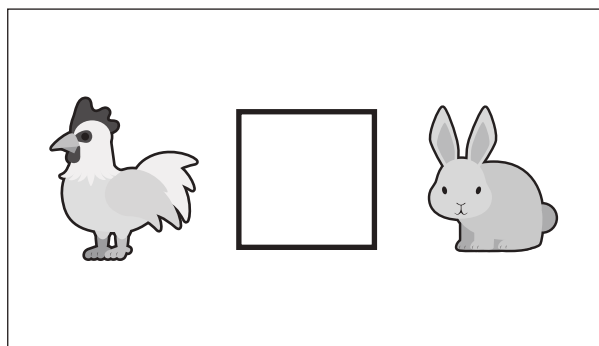
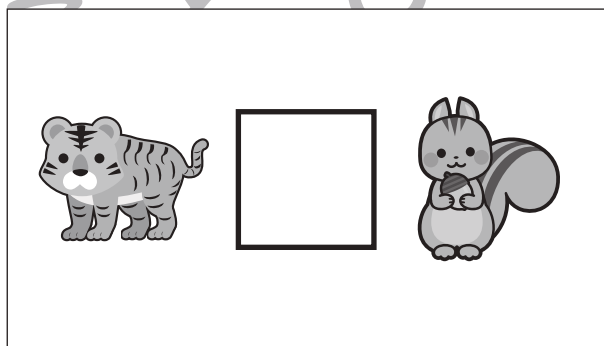
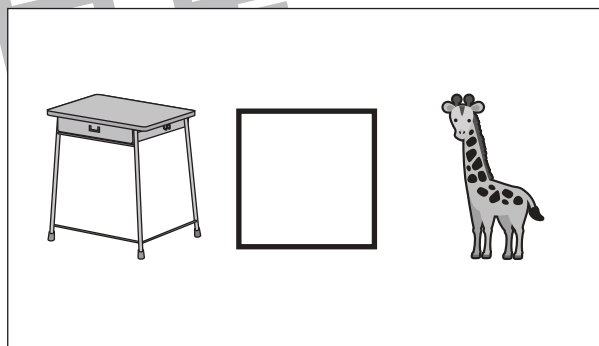
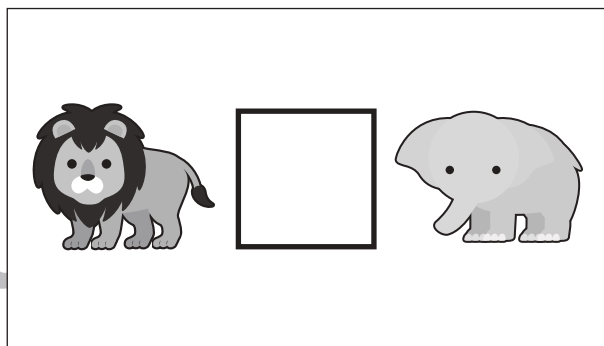
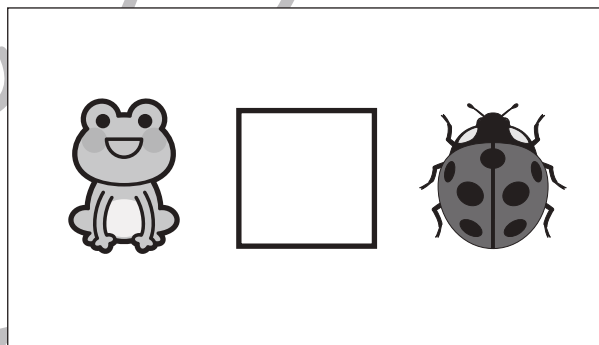
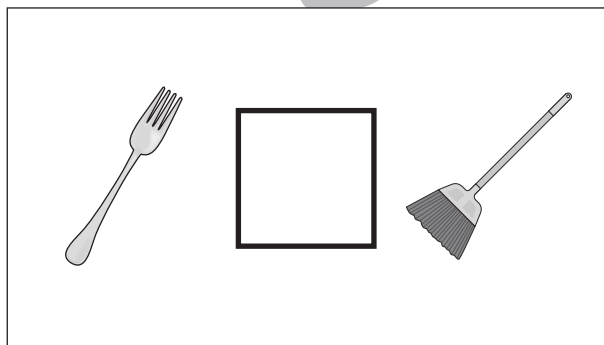
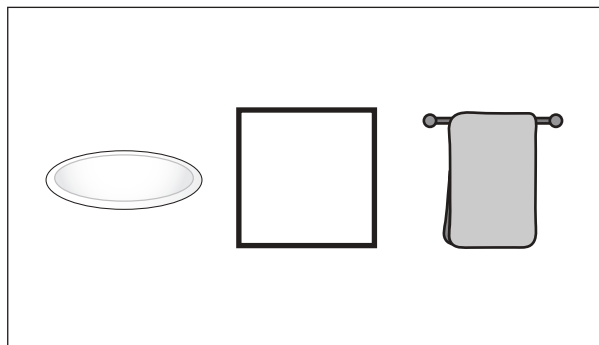
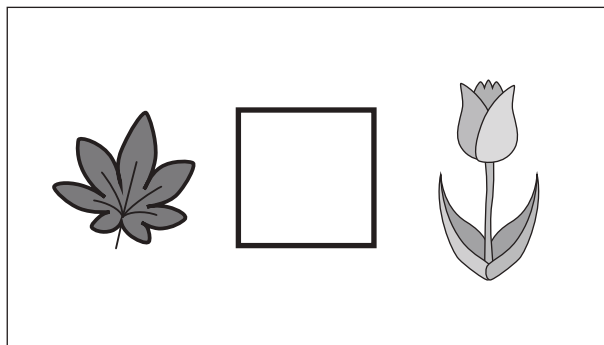

※1. このプリントは、しながわ・目黒こどもスクールのウェブサイトからダウンロードできます。無断複写・引用はご遠慮ください。
※2. このプリントを活用したオンライン授業のスケジュールは、しながわ・目黒こどもスクールのウェブサイトでご確認ください。





おうちで、やろう。

Study at home. 小学校受験の家庭学習教材

言語：数え方4

四角の中の2つの絵の数え方を考えます。数え方が同じときは○、数え方が違うときは×を真ん中の四角の中にかきます。

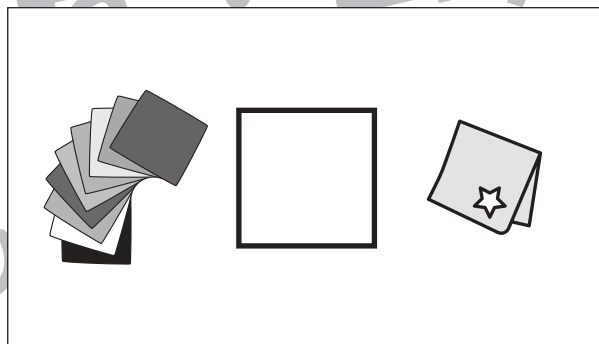
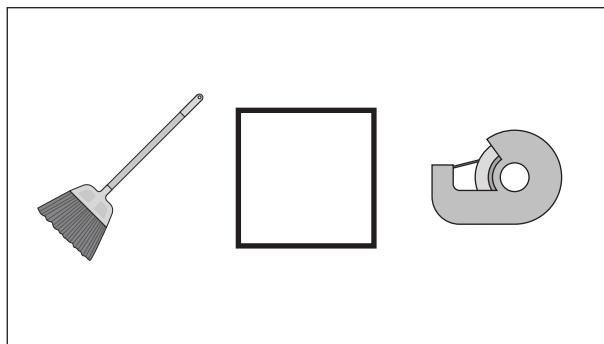
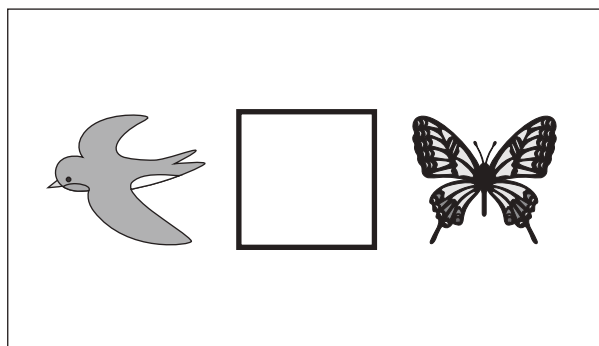
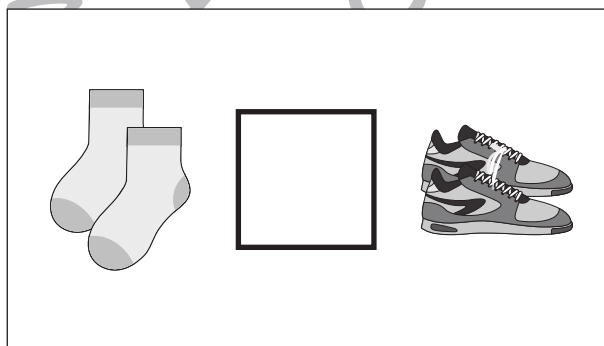
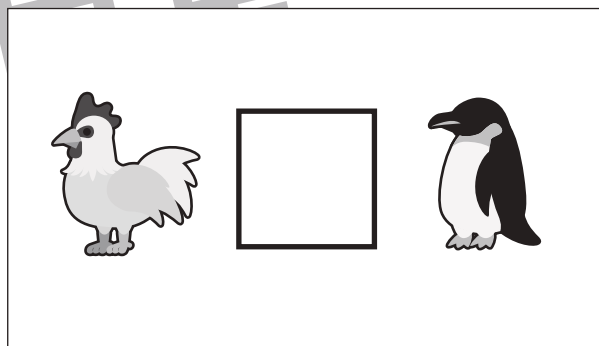
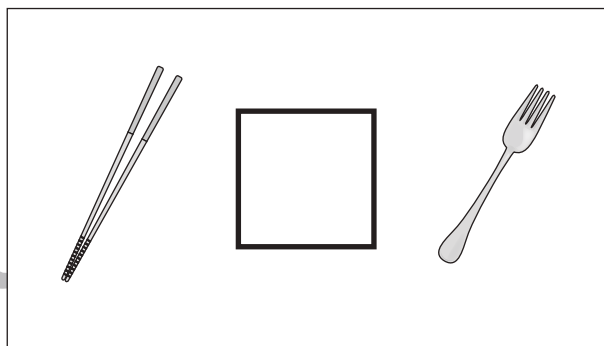
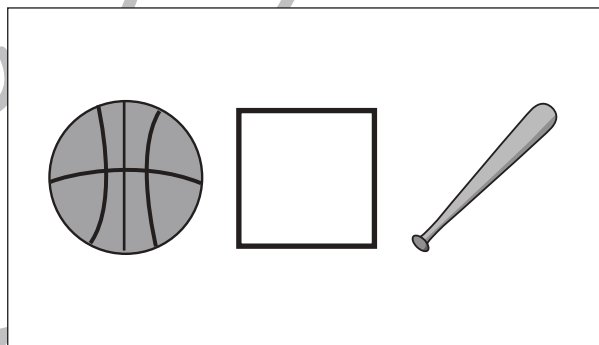
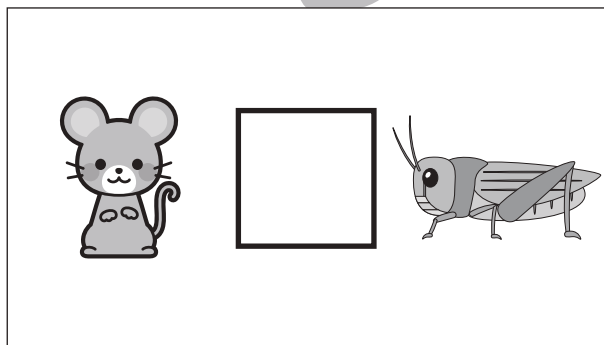
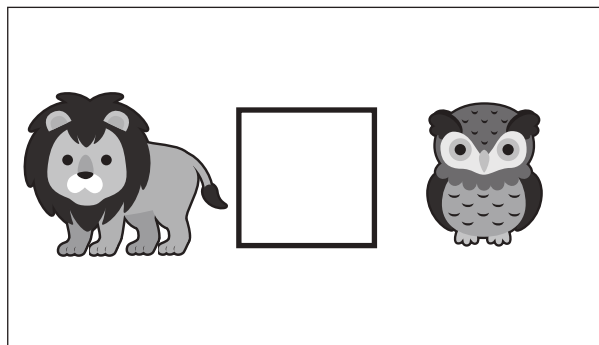
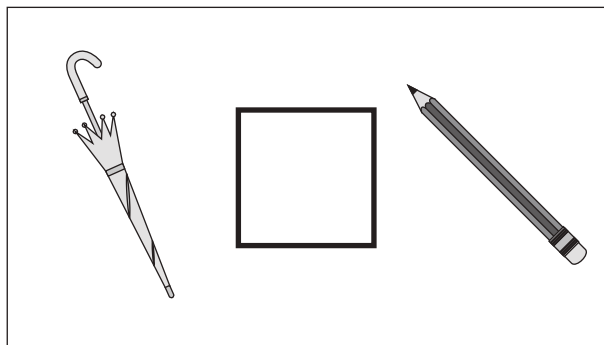

※1. このプリントは、しながわ・目黒こどもスクールのウェブサイトからダウンロードできます。無断複写・引用はご遠慮ください。
※2. このプリントを活用したオンライン授業のスケジュールは、しながわ・目黒こどもスクールのウェブサイトでご確認ください。





おうちで、やろう。

Study at home. 小学校受験の家庭学習教材

常識：断面図2

左は果物、右は果物を半分に切ったときの絵のです。同じもの同士の点と点を線で結びます。

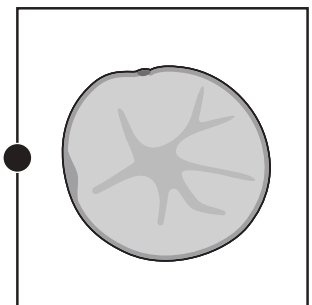
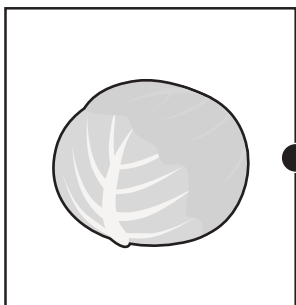
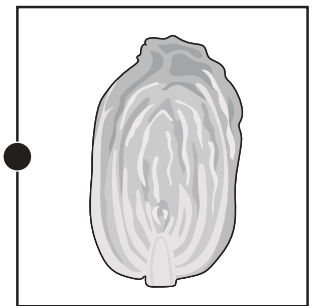
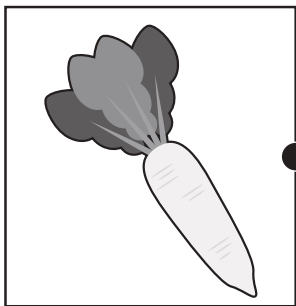
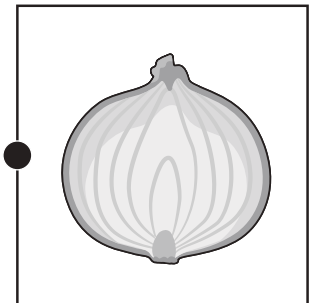
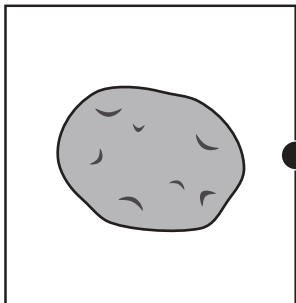
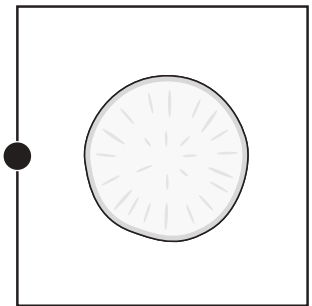
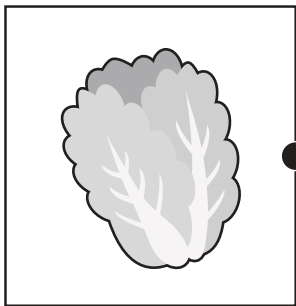
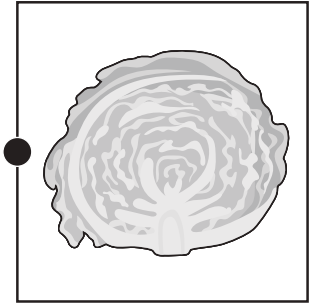
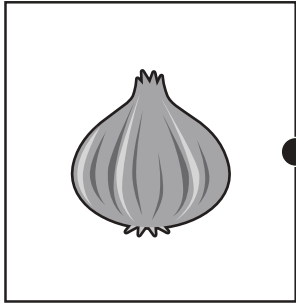

※1. このプリントは、しながわ・目黒こどもスクールのウェブサイトからダウンロードできます。無断複写・引用はご遠慮ください。

※2. このプリントを活用したオンライン授業のスケジュールは、しながわ・目黒こどもスクールのウェブサイトでご確認ください。



おうちで、やろう。

Study at home. 小学校受験の家庭学習教材

常識：断面図3

左は果物、右は果物を半分に切ったときの絵のです。同じもの同士の点と点を線で結びます。

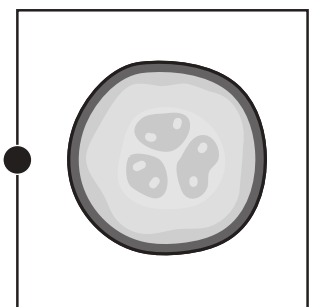
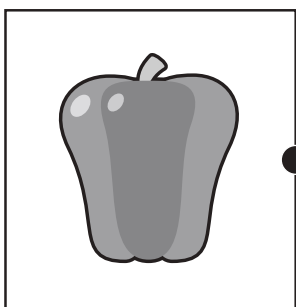
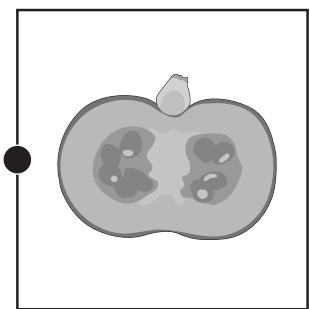
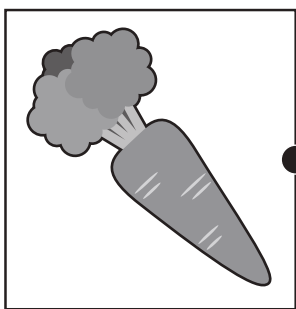
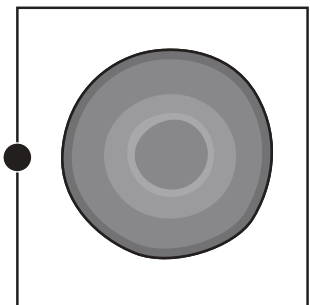
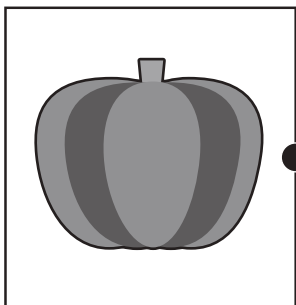
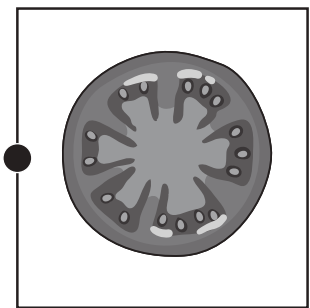
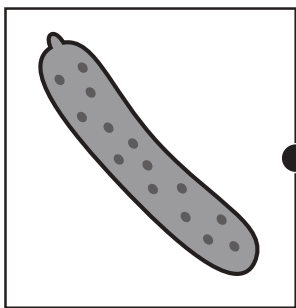
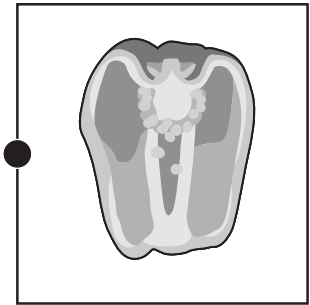
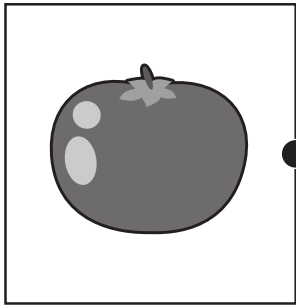

※1. このプリントは、しながわ・目黒こどもスクールのウェブサイトでダウンロードができます。無断複写・引用はご遠慮ください。
※2. このプリントを活用したオンライン授業のスケジュールは、しながわ・目黒こどもスクールのウェブサイトでご確認ください。



おうちで、よろう。

Study at home. 小学校受験の家庭学習教材

図形：回転 25

左のお手本を矢印の方向へ 1 回倒した時の見え方を考えて右の四角の中から見つけて○をつけます。

	<table border="1"> <tr><td></td><td></td><td>○</td><td></td></tr> <tr><td></td><td></td><td></td><td></td></tr> <tr><td></td><td></td><td>○</td><td></td></tr> <tr><td>○</td><td></td><td></td><td>○</td></tr> </table> <table border="1"> <tr><td></td><td></td><td></td><td>○</td></tr> <tr><td></td><td></td><td></td><td></td></tr> <tr><td></td><td></td><td></td><td></td></tr> <tr><td>○</td><td></td><td>○</td><td></td></tr> </table> <table border="1"> <tr><td></td><td></td><td>○</td><td></td></tr> <tr><td></td><td></td><td></td><td></td></tr> <tr><td>○</td><td></td><td></td><td></td></tr> <tr><td></td><td></td><td>○</td><td>○</td></tr> </table> <table border="1"> <tr><td></td><td></td><td></td><td>○</td></tr> <tr><td></td><td></td><td></td><td></td></tr> <tr><td></td><td></td><td></td><td></td></tr> <tr><td>○</td><td></td><td>○</td><td>○</td></tr> </table>			○								○		○			○				○									○		○				○						○						○	○				○									○		○	○
		○																																																															
		○																																																															
○			○																																																														
			○																																																														
○		○																																																															
		○																																																															
○																																																																	
		○	○																																																														
			○																																																														
○		○	○																																																														
	<table border="1"> <tr><td></td><td></td><td>○</td><td></td></tr> <tr><td></td><td></td><td></td><td></td></tr> <tr><td>○</td><td></td><td></td><td>○</td></tr> <tr><td>○</td><td></td><td></td><td>○</td></tr> </table> <table border="1"> <tr><td></td><td>○</td><td></td><td></td></tr> <tr><td></td><td></td><td></td><td></td></tr> <tr><td></td><td></td><td></td><td>○</td></tr> <tr><td></td><td></td><td></td><td>○</td></tr> </table> <table border="1"> <tr><td></td><td>○</td><td></td><td></td></tr> <tr><td></td><td></td><td></td><td></td></tr> <tr><td>○</td><td></td><td></td><td></td></tr> <tr><td>○</td><td></td><td></td><td></td></tr> </table> <table border="1"> <tr><td>○</td><td></td><td></td><td></td></tr> <tr><td></td><td></td><td></td><td></td></tr> <tr><td></td><td></td><td></td><td>○</td></tr> <tr><td></td><td></td><td></td><td>○</td></tr> </table>			○						○			○	○			○		○										○				○		○							○				○				○											○				○
		○																																																															
○			○																																																														
○			○																																																														
	○																																																																
			○																																																														
			○																																																														
	○																																																																
○																																																																	
○																																																																	
○																																																																	
			○																																																														
			○																																																														
	<table border="1"> <tr><td></td><td>○</td><td>○</td><td></td></tr> <tr><td></td><td></td><td></td><td></td></tr> <tr><td></td><td></td><td></td><td></td></tr> <tr><td>○</td><td></td><td></td><td></td></tr> </table> <table border="1"> <tr><td></td><td></td><td></td><td>○</td></tr> <tr><td></td><td></td><td></td><td></td></tr> <tr><td></td><td></td><td></td><td></td></tr> <tr><td></td><td>○</td><td>○</td><td></td></tr> </table> <table border="1"> <tr><td>○</td><td></td><td></td><td></td></tr> <tr><td></td><td></td><td></td><td></td></tr> <tr><td></td><td></td><td></td><td></td></tr> <tr><td>○</td><td></td><td>○</td><td></td></tr> </table> <table border="1"> <tr><td>○</td><td></td><td></td><td></td></tr> <tr><td></td><td></td><td></td><td></td></tr> <tr><td></td><td></td><td></td><td></td></tr> <tr><td></td><td>○</td><td>○</td><td></td></tr> </table>		○	○										○							○										○	○		○												○		○		○													○	○	
	○	○																																																															
○																																																																	
			○																																																														
	○	○																																																															
○																																																																	
○		○																																																															
○																																																																	
	○	○																																																															
	<table border="1"> <tr><td></td><td>○</td><td></td><td></td></tr> <tr><td>○</td><td></td><td></td><td></td></tr> <tr><td></td><td></td><td></td><td></td></tr> <tr><td></td><td></td><td>○</td><td></td></tr> </table> <table border="1"> <tr><td></td><td></td><td></td><td>○</td></tr> <tr><td></td><td></td><td></td><td></td></tr> <tr><td></td><td>○</td><td></td><td></td></tr> <tr><td>○</td><td></td><td></td><td></td></tr> </table> <table border="1"> <tr><td>○</td><td></td><td></td><td></td></tr> <tr><td></td><td></td><td></td><td></td></tr> <tr><td></td><td></td><td></td><td>○</td></tr> <tr><td></td><td>○</td><td></td><td></td></tr> </table> <table border="1"> <tr><td>○</td><td></td><td></td><td></td></tr> <tr><td></td><td></td><td></td><td></td></tr> <tr><td></td><td></td><td></td><td>○</td></tr> <tr><td></td><td></td><td></td><td>○</td></tr> </table>		○			○										○					○						○			○				○											○		○			○											○				○
	○																																																																
○																																																																	
		○																																																															
			○																																																														
	○																																																																
○																																																																	
○																																																																	
			○																																																														
	○																																																																
○																																																																	
			○																																																														
			○																																																														
	<table border="1"> <tr><td>○</td><td></td><td></td><td></td></tr> <tr><td></td><td>○</td><td></td><td></td></tr> <tr><td></td><td></td><td></td><td></td></tr> <tr><td></td><td>○</td><td></td><td></td></tr> </table> <table border="1"> <tr><td></td><td>○</td><td></td><td></td></tr> <tr><td></td><td></td><td></td><td></td></tr> <tr><td></td><td>○</td><td></td><td></td></tr> <tr><td></td><td></td><td></td><td>○</td></tr> </table> <table border="1"> <tr><td></td><td></td><td>○</td><td></td></tr> <tr><td></td><td>○</td><td></td><td></td></tr> <tr><td></td><td></td><td></td><td></td></tr> <tr><td></td><td>○</td><td></td><td></td></tr> </table> <table border="1"> <tr><td>○</td><td></td><td></td><td></td></tr> <tr><td></td><td></td><td></td><td>○</td></tr> <tr><td></td><td></td><td></td><td></td></tr> <tr><td></td><td></td><td></td><td>○</td></tr> </table>	○					○								○				○								○						○			○			○								○			○							○								○
○																																																																	
	○																																																																
	○																																																																
	○																																																																
	○																																																																
			○																																																														
		○																																																															
	○																																																																
	○																																																																
○																																																																	
			○																																																														
			○																																																														

※1. このプリントは、しながわ・目黒こどもスクールのウェブサイトでダウンロードができます。無断複写・引用はご遠慮ください。
 ※2. このプリントを活用したオンライン授業のスケジュールは、しながわ・目黒こどもスクールのウェブサイトでご確認ください。



おうちで、よろう。

Study at home. 小学校受験の家庭学習教材

図形：回転 26

左のお手本を矢印の方向へ 1 回倒した時の見え方を考えて右の四角の中から見つけて○をつけます。

	<table border="1"> <tr><td></td><td></td><td>○</td><td></td></tr> <tr><td></td><td>●</td><td></td><td></td></tr> <tr><td></td><td></td><td></td><td></td></tr> <tr><td>●</td><td>●</td><td>○</td><td></td></tr> </table> <table border="1"> <tr><td></td><td></td><td>●</td><td></td></tr> <tr><td></td><td>○</td><td></td><td></td></tr> <tr><td></td><td></td><td></td><td></td></tr> <tr><td>●</td><td>○</td><td>○</td><td></td></tr> </table> <table border="1"> <tr><td></td><td></td><td>●</td><td></td></tr> <tr><td></td><td>○</td><td></td><td></td></tr> <tr><td></td><td></td><td></td><td></td></tr> <tr><td>●</td><td>●</td><td>○</td><td></td></tr> </table> <table border="1"> <tr><td>○</td><td>●</td><td>●</td><td></td></tr> <tr><td></td><td></td><td></td><td></td></tr> <tr><td></td><td>○</td><td></td><td></td></tr> <tr><td>●</td><td></td><td></td><td></td></tr> </table>			○			●							●	●	○				●			○							●	○	○				●			○							●	●	○		○	●	●							○			●			
		○																																																															
	●																																																																
●	●	○																																																															
		●																																																															
	○																																																																
●	○	○																																																															
		●																																																															
	○																																																																
●	●	○																																																															
○	●	●																																																															
	○																																																																
●																																																																	
	<table border="1"> <tr><td></td><td></td><td></td><td></td></tr> <tr><td></td><td></td><td>●</td><td></td></tr> <tr><td>●</td><td>○</td><td></td><td></td></tr> <tr><td>○</td><td>●</td><td></td><td></td></tr> </table> <table border="1"> <tr><td></td><td>●</td><td>○</td><td></td></tr> <tr><td></td><td>○</td><td>●</td><td></td></tr> <tr><td>●</td><td></td><td></td><td></td></tr> <tr><td></td><td></td><td></td><td></td></tr> </table> <table border="1"> <tr><td></td><td></td><td></td><td></td></tr> <tr><td></td><td></td><td>●</td><td></td></tr> <tr><td>○</td><td>●</td><td></td><td></td></tr> <tr><td>●</td><td>○</td><td></td><td></td></tr> </table> <table border="1"> <tr><td></td><td></td><td></td><td>●</td></tr> <tr><td></td><td></td><td></td><td></td></tr> <tr><td>●</td><td>○</td><td></td><td></td></tr> <tr><td>○</td><td>●</td><td></td><td></td></tr> </table>							●		●	○			○	●				●	○			○	●		●														●		○	●			●	○						●					●	○			○	●		
		●																																																															
●	○																																																																
○	●																																																																
	●	○																																																															
	○	●																																																															
●																																																																	
		●																																																															
○	●																																																																
●	○																																																																
			●																																																														
●	○																																																																
○	●																																																																
	<table border="1"> <tr><td>○</td><td></td><td></td><td></td></tr> <tr><td></td><td></td><td>●</td><td></td></tr> <tr><td></td><td>○</td><td></td><td></td></tr> <tr><td>○</td><td></td><td>●</td><td></td></tr> </table> <table border="1"> <tr><td>●</td><td></td><td></td><td></td></tr> <tr><td></td><td></td><td>○</td><td></td></tr> <tr><td></td><td>●</td><td></td><td></td></tr> <tr><td>●</td><td></td><td>○</td><td></td></tr> </table> <table border="1"> <tr><td></td><td></td><td></td><td>●</td></tr> <tr><td>○</td><td></td><td></td><td></td></tr> <tr><td></td><td>●</td><td></td><td></td></tr> <tr><td>○</td><td></td><td>●</td><td></td></tr> </table> <table border="1"> <tr><td>●</td><td></td><td></td><td></td></tr> <tr><td></td><td></td><td></td><td>○</td></tr> <tr><td></td><td>○</td><td></td><td></td></tr> <tr><td>●</td><td></td><td></td><td>○</td></tr> </table>	○						●			○			○		●		●						○			●			●		○					●	○					●			○		●		●							○		○			●			○
○																																																																	
		●																																																															
	○																																																																
○		●																																																															
●																																																																	
		○																																																															
	●																																																																
●		○																																																															
			●																																																														
○																																																																	
	●																																																																
○		●																																																															
●																																																																	
			○																																																														
	○																																																																
●			○																																																														
	<table border="1"> <tr><td></td><td></td><td>●</td><td></td></tr> <tr><td></td><td>●</td><td></td><td></td></tr> <tr><td>○</td><td></td><td>○</td><td></td></tr> <tr><td></td><td>●</td><td></td><td></td></tr> </table> <table border="1"> <tr><td></td><td>●</td><td></td><td></td></tr> <tr><td>○</td><td></td><td>○</td><td></td></tr> <tr><td></td><td>●</td><td></td><td></td></tr> <tr><td>○</td><td></td><td></td><td></td></tr> </table> <table border="1"> <tr><td></td><td></td><td></td><td>○</td></tr> <tr><td></td><td>●</td><td></td><td></td></tr> <tr><td>○</td><td></td><td>●</td><td></td></tr> <tr><td></td><td>○</td><td></td><td></td></tr> </table> <table border="1"> <tr><td></td><td></td><td></td><td>○</td></tr> <tr><td></td><td>●</td><td></td><td></td></tr> <tr><td>○</td><td></td><td>○</td><td></td></tr> <tr><td></td><td>●</td><td></td><td></td></tr> </table>			●			●			○		○			●				●			○		○			●			○							○		●			○		●			○						○		●			○		○			●		
		●																																																															
	●																																																																
○		○																																																															
	●																																																																
	●																																																																
○		○																																																															
	●																																																																
○																																																																	
			○																																																														
	●																																																																
○		●																																																															
	○																																																																
			○																																																														
	●																																																																
○		○																																																															
	●																																																																
	<table border="1"> <tr><td></td><td>○</td><td></td><td></td></tr> <tr><td>●</td><td></td><td>○</td><td></td></tr> <tr><td></td><td>○</td><td>●</td><td></td></tr> <tr><td></td><td></td><td></td><td></td></tr> </table> <table border="1"> <tr><td></td><td></td><td></td><td></td></tr> <tr><td>●</td><td>○</td><td></td><td></td></tr> <tr><td>○</td><td></td><td>●</td><td></td></tr> <tr><td></td><td>○</td><td></td><td></td></tr> </table> <table border="1"> <tr><td></td><td></td><td></td><td></td></tr> <tr><td>●</td><td>○</td><td></td><td></td></tr> <tr><td>○</td><td></td><td>○</td><td></td></tr> <tr><td></td><td>●</td><td></td><td></td></tr> </table> <table border="1"> <tr><td></td><td></td><td></td><td></td></tr> <tr><td>○</td><td>○</td><td></td><td></td></tr> <tr><td>●</td><td></td><td>●</td><td></td></tr> <tr><td></td><td>○</td><td></td><td></td></tr> </table>		○			●		○			○	●										●	○			○		●			○							●	○			○		○			●							○	○			●		●			○		
	○																																																																
●		○																																																															
	○	●																																																															
●	○																																																																
○		●																																																															
	○																																																																
●	○																																																																
○		○																																																															
	●																																																																
○	○																																																																
●		●																																																															
	○																																																																

※1. このプリントは、しながわ・目黒こどもスクールのウェブサイトでダウンロードができます。無断複写・引用はご遠慮ください。
 ※2. このプリントを活用したオンライン授業のスケジュールは、しながわ・目黒こどもスクールのウェブサイトでご確認ください。



おうちで、やろう。

Study at home. 小学校受験の家庭学習教材

図形：回転 27

左のお手本を矢印の方向へ 1 回倒した時の見え方を考えて右の四角の中から見つけて○をつけます。

	<table border="1"> <tr><td>●</td><td></td><td>●</td></tr> <tr><td></td><td>○</td><td></td></tr> <tr><td>△</td><td>●</td><td></td></tr> <tr><td></td><td></td><td>○</td></tr> </table> <table border="1"> <tr><td>●</td><td></td><td>●</td></tr> <tr><td></td><td>●</td><td></td></tr> <tr><td>▷</td><td>○</td><td></td></tr> <tr><td></td><td></td><td>○</td></tr> </table> <table border="1"> <tr><td>●</td><td></td><td>●</td></tr> <tr><td></td><td>○</td><td></td></tr> <tr><td>▷</td><td>●</td><td></td></tr> <tr><td></td><td></td><td>●</td></tr> </table> <table border="1"> <tr><td>●</td><td></td><td>●</td></tr> <tr><td></td><td>○</td><td></td></tr> <tr><td>▷</td><td>●</td><td></td></tr> <tr><td></td><td></td><td>○</td></tr> </table>	●		●		○		△	●				○	●		●		●		▷	○				○	●		●		○		▷	●				●	●		●		○		▷	●				○
●		●																																															
	○																																																
△	●																																																
		○																																															
●		●																																															
	●																																																
▷	○																																																
		○																																															
●		●																																															
	○																																																
▷	●																																																
		●																																															
●		●																																															
	○																																																
▷	●																																																
		○																																															
	<table border="1"> <tr><td>▷</td><td>●</td><td>△</td></tr> <tr><td></td><td></td><td>○</td></tr> <tr><td>●</td><td>○</td><td>●</td></tr> <tr><td>○</td><td></td><td></td></tr> </table> <table border="1"> <tr><td></td><td></td><td>○</td></tr> <tr><td>●</td><td>○</td><td>●</td></tr> <tr><td></td><td></td><td></td></tr> <tr><td>△</td><td>●</td><td>▷</td></tr> </table> <table border="1"> <tr><td>△</td><td>●</td><td>▷</td></tr> <tr><td></td><td></td><td></td></tr> <tr><td>●</td><td>○</td><td>●</td></tr> <tr><td>○</td><td></td><td></td></tr> </table> <table border="1"> <tr><td>△</td><td>●</td><td>△</td></tr> <tr><td></td><td></td><td></td></tr> <tr><td>●</td><td>○</td><td>●</td></tr> <tr><td>○</td><td></td><td></td></tr> </table>	▷	●	△			○	●	○	●	○					○	●	○	●				△	●	▷	△	●	▷				●	○	●	○			△	●	△				●	○	●	○		
▷	●	△																																															
		○																																															
●	○	●																																															
○																																																	
		○																																															
●	○	●																																															
△	●	▷																																															
△	●	▷																																															
●	○	●																																															
○																																																	
△	●	△																																															
●	○	●																																															
○																																																	
	<table border="1"> <tr><td>○</td><td>△</td><td>●</td></tr> <tr><td></td><td></td><td></td></tr> <tr><td>△</td><td></td><td>○</td></tr> <tr><td></td><td>●</td><td>○</td></tr> </table> <table border="1"> <tr><td>○</td><td>●</td><td></td></tr> <tr><td>○</td><td></td><td>▷</td></tr> <tr><td></td><td></td><td></td></tr> <tr><td>●</td><td>▽</td><td>○</td></tr> </table> <table border="1"> <tr><td>○</td><td></td><td>●</td></tr> <tr><td>○</td><td></td><td>▷</td></tr> <tr><td></td><td></td><td></td></tr> <tr><td>●</td><td>▽</td><td>○</td></tr> </table> <table border="1"> <tr><td>○</td><td>●</td><td></td></tr> <tr><td>○</td><td></td><td>▷</td></tr> <tr><td></td><td></td><td></td></tr> <tr><td>●</td><td>△</td><td>○</td></tr> </table>	○	△	●				△		○		●	○	○	●		○		▷				●	▽	○	○		●	○		▷				●	▽	○	○	●		○		▷				●	△	○
○	△	●																																															
△		○																																															
	●	○																																															
○	●																																																
○		▷																																															
●	▽	○																																															
○		●																																															
○		▷																																															
●	▽	○																																															
○	●																																																
○		▷																																															
●	△	○																																															
	<table border="1"> <tr><td>△</td><td>●</td><td></td></tr> <tr><td>○</td><td></td><td>○</td></tr> <tr><td></td><td>●</td><td></td></tr> <tr><td>○</td><td></td><td>▽</td></tr> </table> <table border="1"> <tr><td>△</td><td></td><td>○</td></tr> <tr><td></td><td>●</td><td></td></tr> <tr><td>○</td><td></td><td>○</td></tr> <tr><td></td><td>○</td><td>▽</td></tr> </table> <table border="1"> <tr><td>△</td><td></td><td>○</td></tr> <tr><td></td><td>●</td><td></td></tr> <tr><td>○</td><td></td><td>○</td></tr> <tr><td></td><td>●</td><td>▽</td></tr> </table> <table border="1"> <tr><td>▽</td><td></td><td>○</td></tr> <tr><td></td><td>●</td><td></td></tr> <tr><td>○</td><td></td><td>○</td></tr> <tr><td></td><td>●</td><td>△</td></tr> </table>	△	●		○		○		●		○		▽	△		○		●		○		○		○	▽	△		○		●		○		○		●	▽	▽		○		●		○		○		●	△
△	●																																																
○		○																																															
	●																																																
○		▽																																															
△		○																																															
	●																																																
○		○																																															
	○	▽																																															
△		○																																															
	●																																																
○		○																																															
	●	▽																																															
▽		○																																															
	●																																																
○		○																																															
	●	△																																															
	<table border="1"> <tr><td>○</td><td>▽</td><td></td></tr> <tr><td></td><td></td><td></td></tr> <tr><td>●</td><td>●</td><td>●</td></tr> <tr><td></td><td>○</td><td>△</td></tr> </table> <table border="1"> <tr><td>○</td><td>△</td><td></td></tr> <tr><td></td><td></td><td></td></tr> <tr><td>●</td><td>○</td><td>●</td></tr> <tr><td></td><td>○</td><td>△</td></tr> </table> <table border="1"> <tr><td>○</td><td>▽</td><td></td></tr> <tr><td></td><td></td><td></td></tr> <tr><td>●</td><td>○</td><td>●</td></tr> <tr><td></td><td>○</td><td>▷</td></tr> </table> <table border="1"> <tr><td>○</td><td>▽</td><td></td></tr> <tr><td></td><td></td><td></td></tr> <tr><td>●</td><td>○</td><td>●</td></tr> <tr><td></td><td>○</td><td>△</td></tr> </table>	○	▽					●	●	●		○	△	○	△					●	○	●		○	△	○	▽					●	○	●		○	▷	○	▽					●	○	●		○	△
○	▽																																																
●	●	●																																															
	○	△																																															
○	△																																																
●	○	●																																															
	○	△																																															
○	▽																																																
●	○	●																																															
	○	▷																																															
○	▽																																																
●	○	●																																															
	○	△																																															

※1. このプリントは、しながわ・目黒こどもスクールのウェブサイトでダウンロードができます。無断複写・引用はご遠慮ください。
 ※2. このプリントを活用したオンライン授業のスケジュールは、しながわ・目黒こどもスクールのウェブサイトでご確認ください。



おうちで、やろう。

Study at home. 小学校受験の家庭学習教材

図形：回転 27

左のお手本を矢印の方向へ 1 回倒した時の見え方を考えて右の四角の中から見つけて○をつけます。

※1. このプリントは、しながわ・目黒こどもスクールのウェブサイトでダウンロードができます。無断複写・引用はご遠慮ください。

※2. このプリントを活用したオンライン授業のスケジュールは、しながわ・目黒こどもスクールのウェブサイトでご確認ください。



おうちで、よろう。

Study at home. 小学校受験の家庭学習教材

処理：観察力1

左には点と点を通った線がかいてあります。線がかいていない点をすべて見つけて、右の四角に○をつけます。
この問題はスピードを意識して取り組む練習をしてみましょう。(1分～1分30秒)

※1. このプリントは、しながわ・目黒こどもスクールのウェブサイトでダウンロードができます。無断複写・引用はご遠慮ください。
※2. このプリントを活用したオンライン授業のスケジュールは、しながわ・目黒こどもスクールのウェブサイトでご確認ください。