



おうちで、やろう。

Study at home. 小学校受験の家庭学習教材

図形：重ね 21

左の四角の中には3枚の透明なマスがあります。この3枚を重ねた時、白丸の場所を考えて、右の四角に○をかきます。

<table border="1"> <tr><td>●</td><td>●</td><td>○</td></tr> <tr><td>○</td><td>●</td><td>○</td></tr> <tr><td>○</td><td>●</td><td>○</td></tr> </table>	●	●	○	○	●	○	○	●	○	<table border="1"> <tr><td>○</td><td>○</td><td>○</td></tr> <tr><td>●</td><td>●</td><td>○</td></tr> <tr><td>●</td><td>○</td><td>●</td></tr> </table>	○	○	○	●	●	○	●	○	●	<table border="1"> <tr><td>○</td><td>○</td><td>●</td></tr> <tr><td>○</td><td>●</td><td>○</td></tr> <tr><td>○</td><td>○</td><td>○</td></tr> </table>	○	○	●	○	●	○	○	○	○	<table border="1"> <tr><td></td><td></td><td></td></tr> <tr><td></td><td></td><td></td></tr> <tr><td></td><td></td><td></td></tr> </table>									
●	●	○																																					
○	●	○																																					
○	●	○																																					
○	○	○																																					
●	●	○																																					
●	○	●																																					
○	○	●																																					
○	●	○																																					
○	○	○																																					
<table border="1"> <tr><td>○</td><td>○</td><td>●</td></tr> <tr><td>○</td><td>●</td><td>●</td></tr> <tr><td>○</td><td>●</td><td>○</td></tr> </table>	○	○	●	○	●	●	○	●	○	<table border="1"> <tr><td>○</td><td>●</td><td>○</td></tr> <tr><td>●</td><td>○</td><td>●</td></tr> <tr><td>○</td><td>●</td><td>○</td></tr> </table>	○	●	○	●	○	●	○	●	○	<table border="1"> <tr><td>○</td><td>○</td><td>○</td></tr> <tr><td>●</td><td>○</td><td>●</td></tr> <tr><td>●</td><td>○</td><td>○</td></tr> </table>	○	○	○	●	○	●	●	○	○	<table border="1"> <tr><td></td><td></td><td></td></tr> <tr><td></td><td></td><td></td></tr> <tr><td></td><td></td><td></td></tr> </table>									
○	○	●																																					
○	●	●																																					
○	●	○																																					
○	●	○																																					
●	○	●																																					
○	●	○																																					
○	○	○																																					
●	○	●																																					
●	○	○																																					
<table border="1"> <tr><td>○</td><td>○</td><td>●</td></tr> <tr><td>○</td><td>●</td><td>○</td></tr> <tr><td>●</td><td>○</td><td>○</td></tr> </table>	○	○	●	○	●	○	●	○	○	<table border="1"> <tr><td>●</td><td>○</td><td>○</td></tr> <tr><td>○</td><td>●</td><td>○</td></tr> <tr><td>○</td><td>○</td><td>●</td></tr> </table>	●	○	○	○	●	○	○	○	●	<table border="1"> <tr><td>○</td><td>○</td><td>○</td></tr> <tr><td>●</td><td>●</td><td>●</td></tr> <tr><td>○</td><td>○</td><td>○</td></tr> </table>	○	○	○	●	●	●	○	○	○	<table border="1"> <tr><td></td><td></td><td></td></tr> <tr><td></td><td></td><td></td></tr> <tr><td></td><td></td><td></td></tr> </table>									
○	○	●																																					
○	●	○																																					
●	○	○																																					
●	○	○																																					
○	●	○																																					
○	○	●																																					
○	○	○																																					
●	●	●																																					
○	○	○																																					
<table border="1"> <tr><td>●</td><td>○</td><td>●</td></tr> <tr><td>●</td><td>○</td><td>●</td></tr> <tr><td>○</td><td>○</td><td>○</td></tr> </table>	●	○	●	●	○	●	○	○	○	<table border="1"> <tr><td>○</td><td>●</td><td>●</td></tr> <tr><td>●</td><td>●</td><td>○</td></tr> <tr><td>○</td><td>○</td><td>○</td></tr> </table>	○	●	●	●	●	○	○	○	○	<table border="1"> <tr><td>○</td><td>○</td><td>●</td></tr> <tr><td>●</td><td>●</td><td>○</td></tr> <tr><td>●</td><td>○</td><td>○</td></tr> </table>	○	○	●	●	●	○	●	○	○	<table border="1"> <tr><td></td><td></td><td></td></tr> <tr><td></td><td></td><td></td></tr> <tr><td></td><td></td><td></td></tr> </table>									
●	○	●																																					
●	○	●																																					
○	○	○																																					
○	●	●																																					
●	●	○																																					
○	○	○																																					
○	○	●																																					
●	●	○																																					
●	○	○																																					
<table border="1"> <tr><td>○</td><td>○</td><td>○</td></tr> <tr><td>○</td><td>●</td><td>●</td></tr> <tr><td>○</td><td>●</td><td>○</td></tr> </table>	○	○	○	○	●	●	○	●	○	<table border="1"> <tr><td>○</td><td>○</td><td>○</td></tr> <tr><td>○</td><td>●</td><td>○</td></tr> <tr><td>●</td><td>●</td><td>○</td></tr> </table>	○	○	○	○	●	○	●	●	○	<table border="1"> <tr><td>●</td><td>●</td><td>○</td></tr> <tr><td>○</td><td>●</td><td>○</td></tr> <tr><td>○</td><td>○</td><td>○</td></tr> </table>	●	●	○	○	●	○	○	○	○	<table border="1"> <tr><td></td><td></td><td></td></tr> <tr><td></td><td></td><td></td></tr> <tr><td></td><td></td><td></td></tr> </table>									
○	○	○																																					
○	●	●																																					
○	●	○																																					
○	○	○																																					
○	●	○																																					
●	●	○																																					
●	●	○																																					
○	●	○																																					
○	○	○																																					

※1. このプリントは、しながわ・目黒こどもスクールのウェブサイトでダウンロードができます。無断複写・引用はご遠慮ください。

※2. このプリントを活用したオンライン授業のスケジュールは、しながわ・目黒こどもスクールのウェブサイトでご確認ください。



おうちで、やろう。

Study at home. 小学校受験の家庭学習教材

図形：重ね 22

左の四角の中には3枚の透明なマスがあります。この3枚を重ねた時、白丸の場所を考えて、右の四角に○をかきます。

<table border="1"> <tr><td>●</td><td>●</td><td>○</td></tr> <tr><td>○</td><td>○</td><td>●</td></tr> <tr><td>○</td><td>○</td><td>●</td></tr> </table> <table border="1"> <tr><td>○</td><td>●</td><td>○</td></tr> <tr><td>●</td><td>●</td><td>○</td></tr> <tr><td>○</td><td>○</td><td>○</td></tr> </table> <table border="1"> <tr><td>○</td><td>○</td><td>○</td></tr> <tr><td>●</td><td>●</td><td>●</td></tr> <tr><td>●</td><td>○</td><td>○</td></tr> </table> <table border="1"> <tr><td></td><td></td><td></td></tr> <tr><td></td><td></td><td></td></tr> <tr><td></td><td></td><td></td></tr> </table>	●	●	○	○	○	●	○	○	●	○	●	○	●	●	○	○	○	○	○	○	○	●	●	●	●	○	○										<table border="1"> <tr><td>○</td><td>○</td><td>●</td></tr> <tr><td>○</td><td>●</td><td>●</td></tr> <tr><td>●</td><td>○</td><td>○</td></tr> </table> <table border="1"> <tr><td>●</td><td>○</td><td>○</td></tr> <tr><td>○</td><td>●</td><td>○</td></tr> <tr><td>○</td><td>○</td><td>●</td></tr> </table> <table border="1"> <tr><td>○</td><td>●</td><td>○</td></tr> <tr><td>●</td><td>○</td><td>●</td></tr> <tr><td>○</td><td>○</td><td>○</td></tr> </table> <table border="1"> <tr><td></td><td></td><td></td></tr> <tr><td></td><td></td><td></td></tr> <tr><td></td><td></td><td></td></tr> </table>	○	○	●	○	●	●	●	○	○	●	○	○	○	●	○	○	○	●	○	●	○	●	○	●	○	○	○										<table border="1"> <tr><td>○</td><td>○</td><td>○</td></tr> <tr><td>○</td><td>○</td><td>○</td></tr> <tr><td>○</td><td>●</td><td>●</td></tr> </table> <table border="1"> <tr><td>○</td><td>○</td><td>●</td></tr> <tr><td>○</td><td>○</td><td>●</td></tr> <tr><td>○</td><td>○</td><td>○</td></tr> </table> <table border="1"> <tr><td>●</td><td>○</td><td>○</td></tr> <tr><td>●</td><td>○</td><td>○</td></tr> <tr><td>○</td><td>○</td><td>○</td></tr> </table> <table border="1"> <tr><td></td><td></td><td></td></tr> <tr><td></td><td></td><td></td></tr> <tr><td></td><td></td><td></td></tr> </table>	○	○	○	○	○	○	○	●	●	○	○	●	○	○	●	○	○	○	●	○	○	●	○	○	○	○	○										<table border="1"> <tr><td>○</td><td>○</td><td>○</td></tr> <tr><td>●</td><td>●</td><td>○</td></tr> <tr><td>○</td><td>○</td><td>●</td></tr> </table> <table border="1"> <tr><td>○</td><td>○</td><td>●</td></tr> <tr><td>●</td><td>●</td><td>○</td></tr> <tr><td>○</td><td>○</td><td>○</td></tr> </table> <table border="1"> <tr><td>●</td><td>○</td><td>○</td></tr> <tr><td>●</td><td>○</td><td>○</td></tr> <tr><td>●</td><td>○</td><td>○</td></tr> </table> <table border="1"> <tr><td></td><td></td><td></td></tr> <tr><td></td><td></td><td></td></tr> <tr><td></td><td></td><td></td></tr> </table>	○	○	○	●	●	○	○	○	●	○	○	●	●	●	○	○	○	○	●	○	○	●	○	○	●	○	○										<table border="1"> <tr><td>○</td><td>○</td><td>●</td></tr> <tr><td>●</td><td>○</td><td>●</td></tr> <tr><td>○</td><td>○</td><td>○</td></tr> </table> <table border="1"> <tr><td>○</td><td>●</td><td>○</td></tr> <tr><td>○</td><td>○</td><td>○</td></tr> <tr><td>●</td><td>●</td><td>○</td></tr> </table> <table border="1"> <tr><td>○</td><td>○</td><td>○</td></tr> <tr><td>○</td><td>○</td><td>●</td></tr> <tr><td>○</td><td>●</td><td>●</td></tr> </table> <table border="1"> <tr><td></td><td></td><td></td></tr> <tr><td></td><td></td><td></td></tr> <tr><td></td><td></td><td></td></tr> </table>	○	○	●	●	○	●	○	○	○	○	●	○	○	○	○	●	●	○	○	○	○	○	○	●	○	●	●									
●	●	○																																																																																																																																																																																						
○	○	●																																																																																																																																																																																						
○	○	●																																																																																																																																																																																						
○	●	○																																																																																																																																																																																						
●	●	○																																																																																																																																																																																						
○	○	○																																																																																																																																																																																						
○	○	○																																																																																																																																																																																						
●	●	●																																																																																																																																																																																						
●	○	○																																																																																																																																																																																						
<table border="1"> <tr><td>○</td><td>○</td><td>●</td></tr> <tr><td>○</td><td>●</td><td>●</td></tr> <tr><td>●</td><td>○</td><td>○</td></tr> </table> <table border="1"> <tr><td>●</td><td>○</td><td>○</td></tr> <tr><td>○</td><td>●</td><td>○</td></tr> <tr><td>○</td><td>○</td><td>●</td></tr> </table> <table border="1"> <tr><td>○</td><td>●</td><td>○</td></tr> <tr><td>●</td><td>○</td><td>●</td></tr> <tr><td>○</td><td>○</td><td>○</td></tr> </table> <table border="1"> <tr><td></td><td></td><td></td></tr> <tr><td></td><td></td><td></td></tr> <tr><td></td><td></td><td></td></tr> </table>	○	○	●	○	●	●	●	○	○	●	○	○	○	●	○	○	○	●	○	●	○	●	○	●	○	○	○										<table border="1"> <tr><td>○</td><td>○</td><td>○</td></tr> <tr><td>○</td><td>○</td><td>○</td></tr> <tr><td>○</td><td>●</td><td>●</td></tr> </table> <table border="1"> <tr><td>○</td><td>○</td><td>●</td></tr> <tr><td>○</td><td>○</td><td>●</td></tr> <tr><td>○</td><td>○</td><td>○</td></tr> </table> <table border="1"> <tr><td>●</td><td>○</td><td>○</td></tr> <tr><td>●</td><td>○</td><td>○</td></tr> <tr><td>○</td><td>○</td><td>○</td></tr> </table> <table border="1"> <tr><td></td><td></td><td></td></tr> <tr><td></td><td></td><td></td></tr> <tr><td></td><td></td><td></td></tr> </table>	○	○	○	○	○	○	○	●	●	○	○	●	○	○	●	○	○	○	●	○	○	●	○	○	○	○	○										<table border="1"> <tr><td>○</td><td>○</td><td>○</td></tr> <tr><td>●</td><td>●</td><td>○</td></tr> <tr><td>○</td><td>○</td><td>●</td></tr> </table> <table border="1"> <tr><td>○</td><td>○</td><td>●</td></tr> <tr><td>●</td><td>●</td><td>○</td></tr> <tr><td>○</td><td>○</td><td>○</td></tr> </table> <table border="1"> <tr><td>●</td><td>○</td><td>○</td></tr> <tr><td>●</td><td>○</td><td>○</td></tr> <tr><td>●</td><td>○</td><td>○</td></tr> </table> <table border="1"> <tr><td></td><td></td><td></td></tr> <tr><td></td><td></td><td></td></tr> <tr><td></td><td></td><td></td></tr> </table>	○	○	○	●	●	○	○	○	●	○	○	●	●	●	○	○	○	○	●	○	○	●	○	○	●	○	○										<table border="1"> <tr><td>○</td><td>○</td><td>●</td></tr> <tr><td>●</td><td>○</td><td>●</td></tr> <tr><td>○</td><td>○</td><td>○</td></tr> </table> <table border="1"> <tr><td>○</td><td>●</td><td>○</td></tr> <tr><td>○</td><td>○</td><td>○</td></tr> <tr><td>●</td><td>●</td><td>○</td></tr> </table> <table border="1"> <tr><td>○</td><td>○</td><td>○</td></tr> <tr><td>○</td><td>○</td><td>●</td></tr> <tr><td>○</td><td>●</td><td>●</td></tr> </table> <table border="1"> <tr><td></td><td></td><td></td></tr> <tr><td></td><td></td><td></td></tr> <tr><td></td><td></td><td></td></tr> </table>	○	○	●	●	○	●	○	○	○	○	●	○	○	○	○	●	●	○	○	○	○	○	○	●	○	●	●																																														
○	○	●																																																																																																																																																																																						
○	●	●																																																																																																																																																																																						
●	○	○																																																																																																																																																																																						
●	○	○																																																																																																																																																																																						
○	●	○																																																																																																																																																																																						
○	○	●																																																																																																																																																																																						
○	●	○																																																																																																																																																																																						
●	○	●																																																																																																																																																																																						
○	○	○																																																																																																																																																																																						
<table border="1"> <tr><td>○</td><td>○</td><td>○</td></tr> <tr><td>○</td><td>○</td><td>○</td></tr> <tr><td>○</td><td>●</td><td>●</td></tr> </table> <table border="1"> <tr><td>○</td><td>○</td><td>●</td></tr> <tr><td>○</td><td>○</td><td>●</td></tr> <tr><td>○</td><td>○</td><td>○</td></tr> </table> <table border="1"> <tr><td>●</td><td>○</td><td>○</td></tr> <tr><td>●</td><td>○</td><td>○</td></tr> <tr><td>○</td><td>○</td><td>○</td></tr> </table> <table border="1"> <tr><td></td><td></td><td></td></tr> <tr><td></td><td></td><td></td></tr> <tr><td></td><td></td><td></td></tr> </table>	○	○	○	○	○	○	○	●	●	○	○	●	○	○	●	○	○	○	●	○	○	●	○	○	○	○	○										<table border="1"> <tr><td>○</td><td>○</td><td>○</td></tr> <tr><td>●</td><td>●</td><td>○</td></tr> <tr><td>○</td><td>○</td><td>●</td></tr> </table> <table border="1"> <tr><td>○</td><td>○</td><td>●</td></tr> <tr><td>●</td><td>●</td><td>○</td></tr> <tr><td>○</td><td>○</td><td>○</td></tr> </table> <table border="1"> <tr><td>●</td><td>○</td><td>○</td></tr> <tr><td>●</td><td>○</td><td>○</td></tr> <tr><td>●</td><td>○</td><td>○</td></tr> </table> <table border="1"> <tr><td></td><td></td><td></td></tr> <tr><td></td><td></td><td></td></tr> <tr><td></td><td></td><td></td></tr> </table>	○	○	○	●	●	○	○	○	●	○	○	●	●	●	○	○	○	○	●	○	○	●	○	○	●	○	○										<table border="1"> <tr><td>○</td><td>○</td><td>●</td></tr> <tr><td>●</td><td>○</td><td>●</td></tr> <tr><td>○</td><td>○</td><td>○</td></tr> </table> <table border="1"> <tr><td>○</td><td>●</td><td>○</td></tr> <tr><td>○</td><td>○</td><td>○</td></tr> <tr><td>●</td><td>●</td><td>○</td></tr> </table> <table border="1"> <tr><td>○</td><td>○</td><td>○</td></tr> <tr><td>○</td><td>○</td><td>●</td></tr> <tr><td>○</td><td>●</td><td>●</td></tr> </table> <table border="1"> <tr><td></td><td></td><td></td></tr> <tr><td></td><td></td><td></td></tr> <tr><td></td><td></td><td></td></tr> </table>	○	○	●	●	○	●	○	○	○	○	●	○	○	○	○	●	●	○	○	○	○	○	○	●	○	●	●																																																																																			
○	○	○																																																																																																																																																																																						
○	○	○																																																																																																																																																																																						
○	●	●																																																																																																																																																																																						
○	○	●																																																																																																																																																																																						
○	○	●																																																																																																																																																																																						
○	○	○																																																																																																																																																																																						
●	○	○																																																																																																																																																																																						
●	○	○																																																																																																																																																																																						
○	○	○																																																																																																																																																																																						
<table border="1"> <tr><td>○</td><td>○</td><td>○</td></tr> <tr><td>●</td><td>●</td><td>○</td></tr> <tr><td>○</td><td>○</td><td>●</td></tr> </table> <table border="1"> <tr><td>○</td><td>○</td><td>●</td></tr> <tr><td>●</td><td>●</td><td>○</td></tr> <tr><td>○</td><td>○</td><td>○</td></tr> </table> <table border="1"> <tr><td>●</td><td>○</td><td>○</td></tr> <tr><td>●</td><td>○</td><td>○</td></tr> <tr><td>●</td><td>○</td><td>○</td></tr> </table> <table border="1"> <tr><td></td><td></td><td></td></tr> <tr><td></td><td></td><td></td></tr> <tr><td></td><td></td><td></td></tr> </table>	○	○	○	●	●	○	○	○	●	○	○	●	●	●	○	○	○	○	●	○	○	●	○	○	●	○	○										<table border="1"> <tr><td>○</td><td>○</td><td>●</td></tr> <tr><td>●</td><td>○</td><td>●</td></tr> <tr><td>○</td><td>○</td><td>○</td></tr> </table> <table border="1"> <tr><td>○</td><td>●</td><td>○</td></tr> <tr><td>○</td><td>○</td><td>○</td></tr> <tr><td>●</td><td>●</td><td>○</td></tr> </table> <table border="1"> <tr><td>○</td><td>○</td><td>○</td></tr> <tr><td>○</td><td>○</td><td>●</td></tr> <tr><td>○</td><td>●</td><td>●</td></tr> </table> <table border="1"> <tr><td></td><td></td><td></td></tr> <tr><td></td><td></td><td></td></tr> <tr><td></td><td></td><td></td></tr> </table>	○	○	●	●	○	●	○	○	○	○	●	○	○	○	○	●	●	○	○	○	○	○	○	●	○	●	●																																																																																																																								
○	○	○																																																																																																																																																																																						
●	●	○																																																																																																																																																																																						
○	○	●																																																																																																																																																																																						
○	○	●																																																																																																																																																																																						
●	●	○																																																																																																																																																																																						
○	○	○																																																																																																																																																																																						
●	○	○																																																																																																																																																																																						
●	○	○																																																																																																																																																																																						
●	○	○																																																																																																																																																																																						
<table border="1"> <tr><td>○</td><td>○</td><td>●</td></tr> <tr><td>●</td><td>○</td><td>●</td></tr> <tr><td>○</td><td>○</td><td>○</td></tr> </table> <table border="1"> <tr><td>○</td><td>●</td><td>○</td></tr> <tr><td>○</td><td>○</td><td>○</td></tr> <tr><td>●</td><td>●</td><td>○</td></tr> </table> <table border="1"> <tr><td>○</td><td>○</td><td>○</td></tr> <tr><td>○</td><td>○</td><td>●</td></tr> <tr><td>○</td><td>●</td><td>●</td></tr> </table> <table border="1"> <tr><td></td><td></td><td></td></tr> <tr><td></td><td></td><td></td></tr> <tr><td></td><td></td><td></td></tr> </table>	○	○	●	●	○	●	○	○	○	○	●	○	○	○	○	●	●	○	○	○	○	○	○	●	○	●	●																																																																																																																																																													
○	○	●																																																																																																																																																																																						
●	○	●																																																																																																																																																																																						
○	○	○																																																																																																																																																																																						
○	●	○																																																																																																																																																																																						
○	○	○																																																																																																																																																																																						
●	●	○																																																																																																																																																																																						
○	○	○																																																																																																																																																																																						
○	○	●																																																																																																																																																																																						
○	●	●																																																																																																																																																																																						

※1. このプリントは、しながわ・目黒こどもスクールのウェブサイトでダウンロードができます。無断複写・引用はご遠慮ください。

※2. このプリントを活用したオンライン授業のスケジュールは、しながわ・目黒こどもスクールのウェブサイトでご確認ください。



おうちで、やろう。

Study at home. 小学校受験の家庭学習教材

図形：重ね 23

左の四角の中には3枚の透明なマスがあります。この3枚を重ねた時、白丸の場所を考えて、右の四角に○をかきます。

<table border="1"> <tr><td>○</td><td>●</td><td>○</td></tr> <tr><td>○</td><td>●</td><td>○</td></tr> <tr><td>○</td><td>●</td><td>○</td></tr> </table>	○	●	○	○	●	○	○	●	○	<table border="1"> <tr><td>○</td><td>○</td><td>○</td></tr> <tr><td>●</td><td>●</td><td>○</td></tr> <tr><td>○</td><td>●</td><td>○</td></tr> </table>	○	○	○	●	●	○	○	●	○	<table border="1"> <tr><td>○</td><td>●</td><td>○</td></tr> <tr><td>○</td><td>●</td><td>○</td></tr> <tr><td>○</td><td>○</td><td>●</td></tr> </table>	○	●	○	○	●	○	○	○	●	<table border="1"> <tr><td></td><td></td><td></td></tr> <tr><td></td><td></td><td></td></tr> <tr><td></td><td></td><td></td></tr> </table>									
○	●	○																																					
○	●	○																																					
○	●	○																																					
○	○	○																																					
●	●	○																																					
○	●	○																																					
○	●	○																																					
○	●	○																																					
○	○	●																																					
<table border="1"> <tr><td>○</td><td>●</td><td>○</td></tr> <tr><td>●</td><td>○</td><td>○</td></tr> <tr><td>○</td><td>○</td><td>●</td></tr> </table>	○	●	○	●	○	○	○	○	●	<table border="1"> <tr><td>○</td><td>●</td><td>○</td></tr> <tr><td>●</td><td>○</td><td>○</td></tr> <tr><td>○</td><td>●</td><td>○</td></tr> </table>	○	●	○	●	○	○	○	●	○	<table border="1"> <tr><td>○</td><td>○</td><td>○</td></tr> <tr><td>●</td><td>●</td><td>○</td></tr> <tr><td>○</td><td>●</td><td>○</td></tr> </table>	○	○	○	●	●	○	○	●	○	<table border="1"> <tr><td></td><td></td><td></td></tr> <tr><td></td><td></td><td></td></tr> <tr><td></td><td></td><td></td></tr> </table>									
○	●	○																																					
●	○	○																																					
○	○	●																																					
○	●	○																																					
●	○	○																																					
○	●	○																																					
○	○	○																																					
●	●	○																																					
○	●	○																																					
<table border="1"> <tr><td>○</td><td>○</td><td>●</td></tr> <tr><td>●</td><td>○</td><td>●</td></tr> <tr><td>●</td><td>○</td><td>○</td></tr> </table>	○	○	●	●	○	●	●	○	○	<table border="1"> <tr><td>○</td><td>○</td><td>●</td></tr> <tr><td>●</td><td>●</td><td>●</td></tr> <tr><td>○</td><td>○</td><td>○</td></tr> </table>	○	○	●	●	●	●	○	○	○	<table border="1"> <tr><td>●</td><td>○</td><td>○</td></tr> <tr><td>●</td><td>○</td><td>○</td></tr> <tr><td>○</td><td>○</td><td>●</td></tr> </table>	●	○	○	●	○	○	○	○	●	<table border="1"> <tr><td></td><td></td><td></td></tr> <tr><td></td><td></td><td></td></tr> <tr><td></td><td></td><td></td></tr> </table>									
○	○	●																																					
●	○	●																																					
●	○	○																																					
○	○	●																																					
●	●	●																																					
○	○	○																																					
●	○	○																																					
●	○	○																																					
○	○	●																																					
<table border="1"> <tr><td>○</td><td>●</td><td>○</td></tr> <tr><td>○</td><td>●</td><td>○</td></tr> <tr><td>●</td><td>○</td><td>●</td></tr> </table>	○	●	○	○	●	○	●	○	●	<table border="1"> <tr><td>○</td><td>○</td><td>○</td></tr> <tr><td>○</td><td>●</td><td>○</td></tr> <tr><td>●</td><td>●</td><td>○</td></tr> </table>	○	○	○	○	●	○	●	●	○	<table border="1"> <tr><td>●</td><td>○</td><td>●</td></tr> <tr><td>●</td><td>●</td><td>○</td></tr> <tr><td>○</td><td>○</td><td>○</td></tr> </table>	●	○	●	●	●	○	○	○	○	<table border="1"> <tr><td></td><td></td><td></td></tr> <tr><td></td><td></td><td></td></tr> <tr><td></td><td></td><td></td></tr> </table>									
○	●	○																																					
○	●	○																																					
●	○	●																																					
○	○	○																																					
○	●	○																																					
●	●	○																																					
●	○	●																																					
●	●	○																																					
○	○	○																																					
<table border="1"> <tr><td>○</td><td>○</td><td>●</td></tr> <tr><td>○</td><td>●</td><td>○</td></tr> <tr><td>●</td><td>○</td><td>○</td></tr> </table>	○	○	●	○	●	○	●	○	○	<table border="1"> <tr><td>●</td><td>○</td><td>○</td></tr> <tr><td>○</td><td>○</td><td>●</td></tr> <tr><td>○</td><td>○</td><td>●</td></tr> </table>	●	○	○	○	○	●	○	○	●	<table border="1"> <tr><td>○</td><td>●</td><td>○</td></tr> <tr><td>●</td><td>●</td><td>○</td></tr> <tr><td>○</td><td>○</td><td>○</td></tr> </table>	○	●	○	●	●	○	○	○	○	<table border="1"> <tr><td></td><td></td><td></td></tr> <tr><td></td><td></td><td></td></tr> <tr><td></td><td></td><td></td></tr> </table>									
○	○	●																																					
○	●	○																																					
●	○	○																																					
●	○	○																																					
○	○	●																																					
○	○	●																																					
○	●	○																																					
●	●	○																																					
○	○	○																																					

※1. このプリントは、しながわ・目黒こどもスクールのウェブサイトでダウンロードができます。無断複写・引用はご遠慮ください。

※2. このプリントを活用したオンライン授業のスケジュールは、しながわ・目黒こどもスクールのウェブサイトでご確認ください。



おうちで、やろう。

Study at home. 小学校受験の家庭学習教材

数量：置き換え 9

上の太い四角の中がお約束です。記号のついた箱はいくつかのどんぐりと同じ重さで吊り合っています。下のシーソーが吊り合うためには右側にあといくつのどんぐりを乗せればよいかを考えて、その数だけ矢印の右の四角に○をかきます。

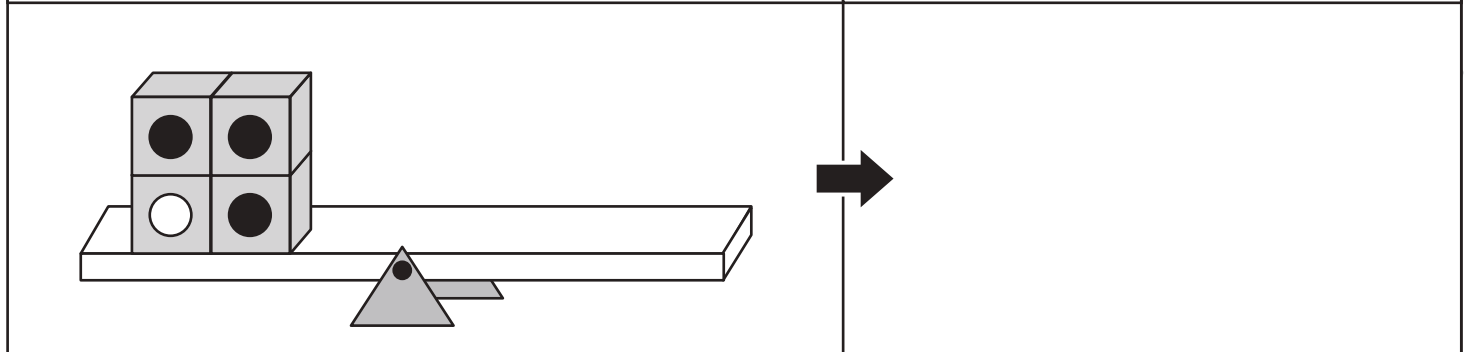
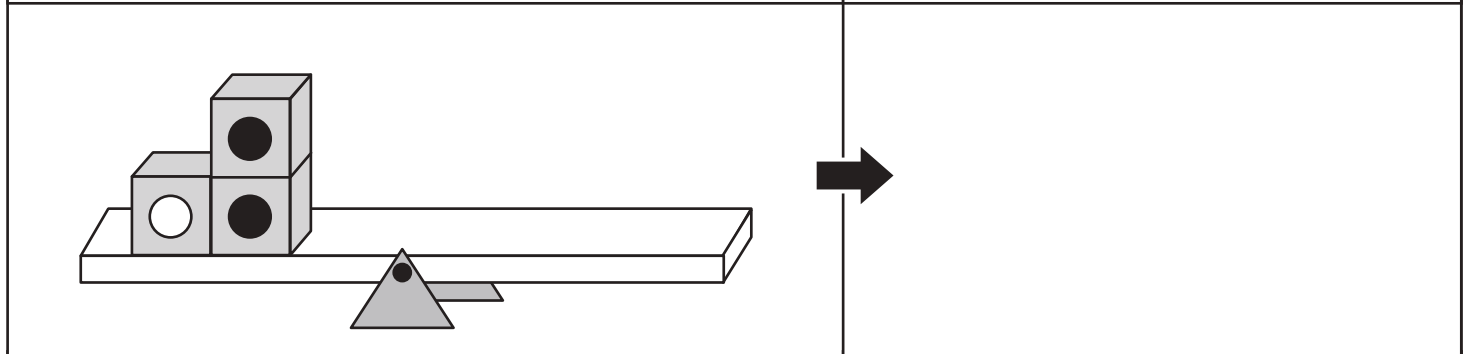
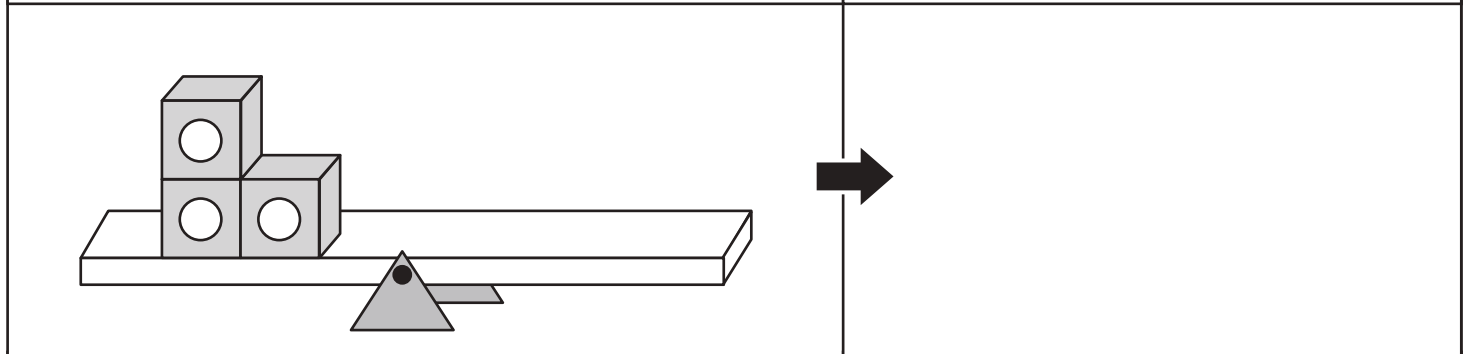
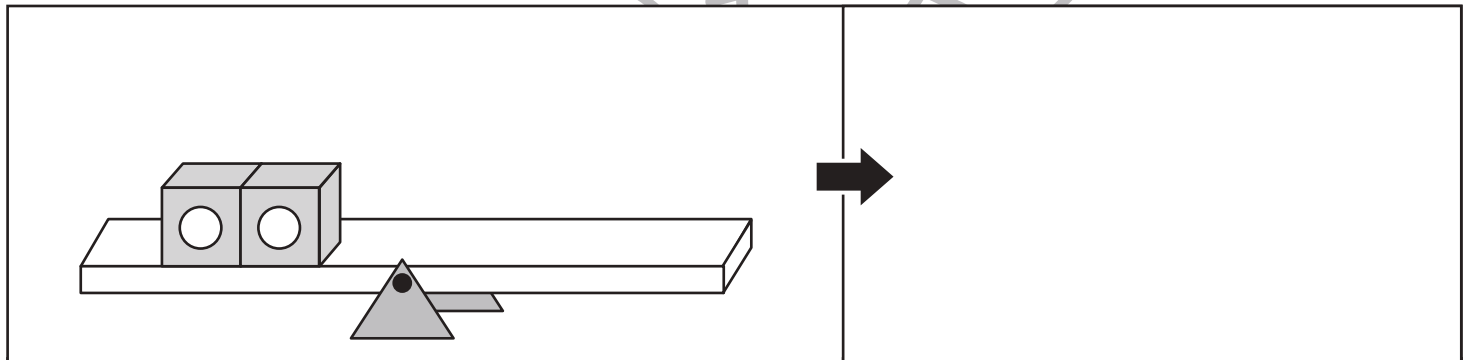
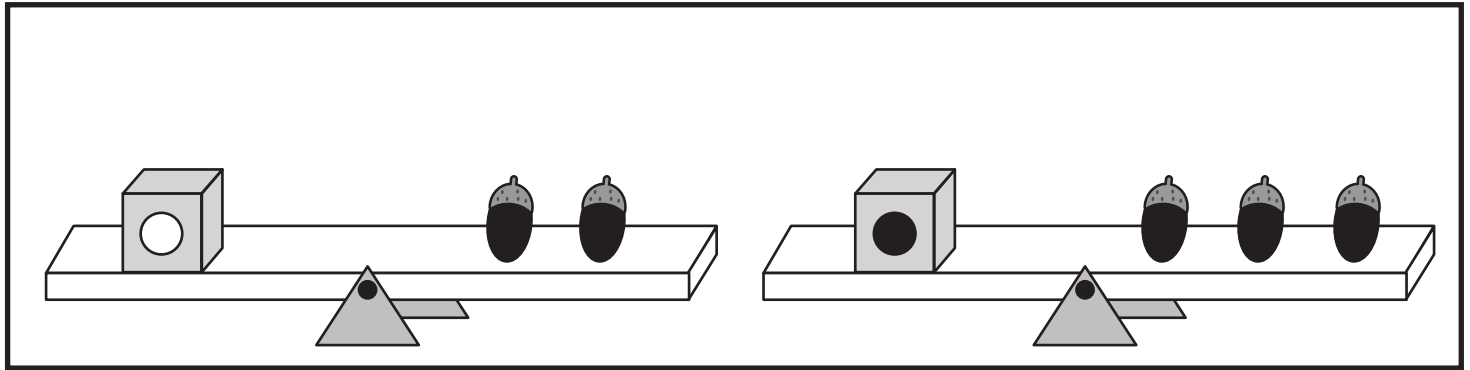

※1. このプリントは、しながわ・目黒こどもスクールのウェブサイトからダウンロードできます。無断複写・引用はご遠慮ください。

※2. このプリントを活用したオンライン授業のスケジュールは、しながわ・目黒こどもスクールのウェブサイトでご確認ください。





おうちで、やろう。

Study at home. 小学校受験の家庭学習教材

数量：置き換え 10

上の太い四角の中がお約束です。記号のついた箱はいくつかのドングリと同じ重さで吊り合っています。下のシーソーが釣り合うためには右側にあといくつのドングリを乗せればよいかを考えて、その数だけ矢印の右の四角に○をかきます。

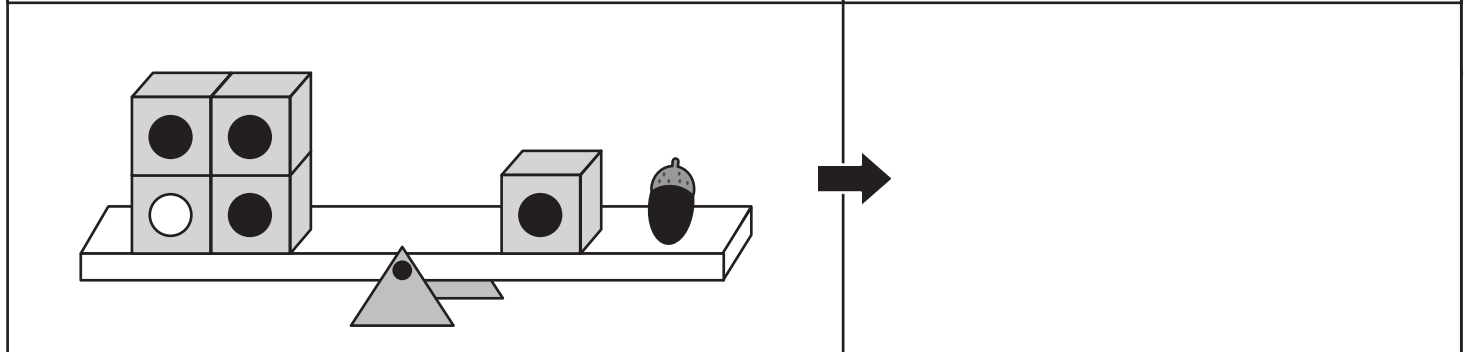
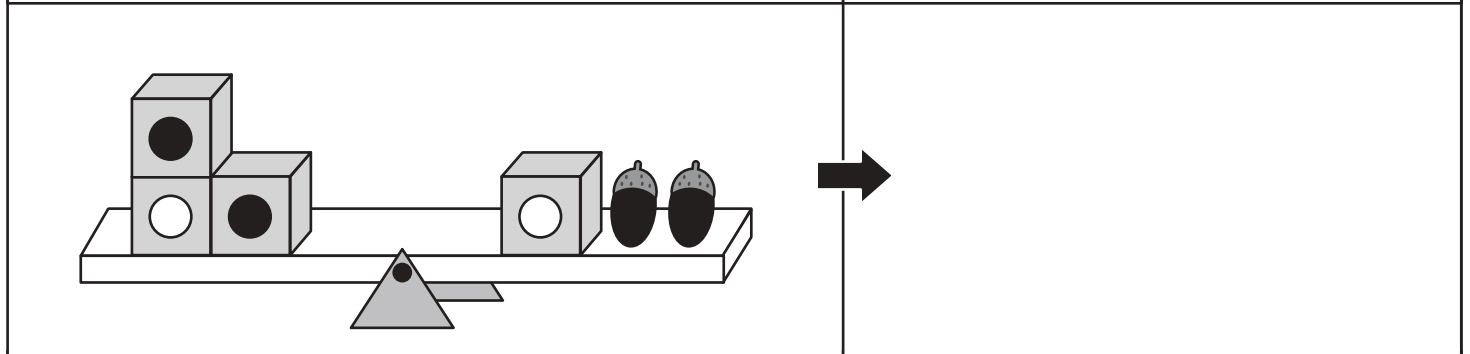
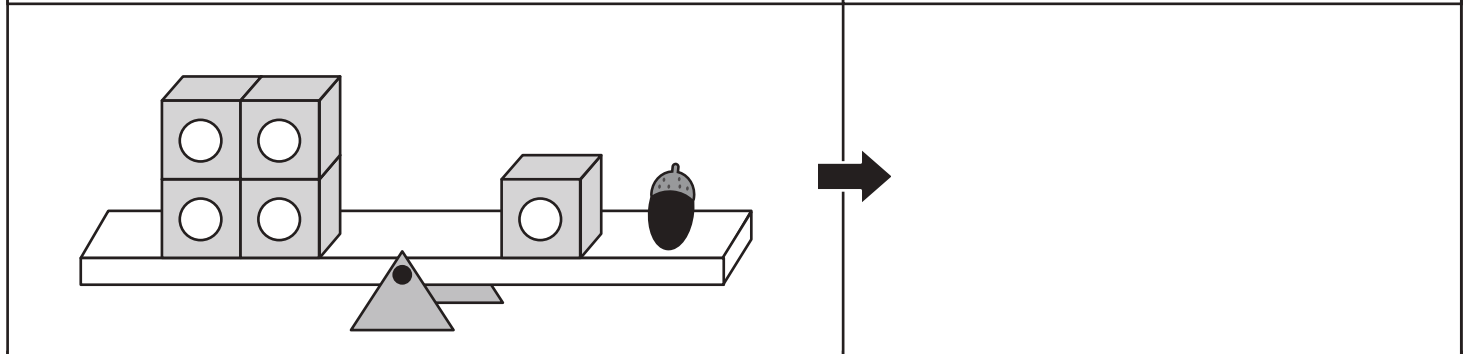
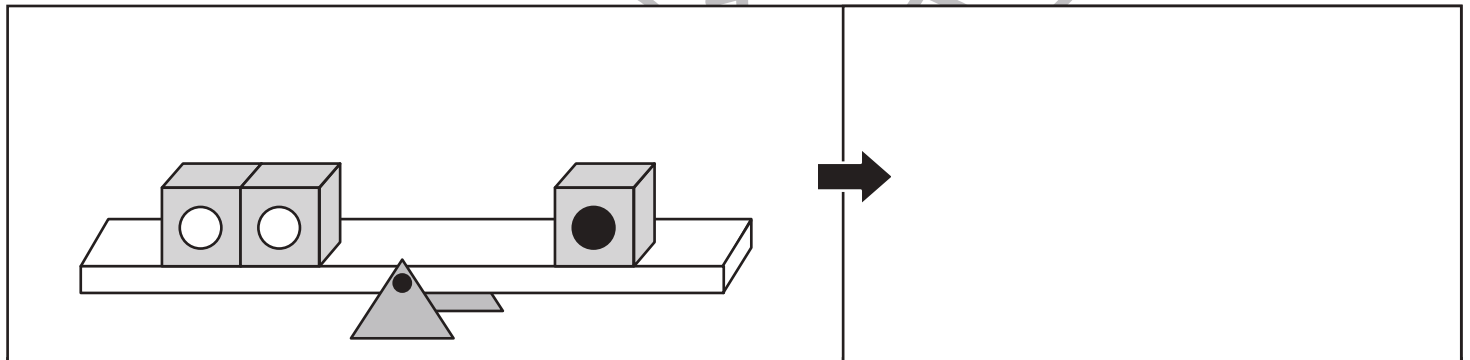
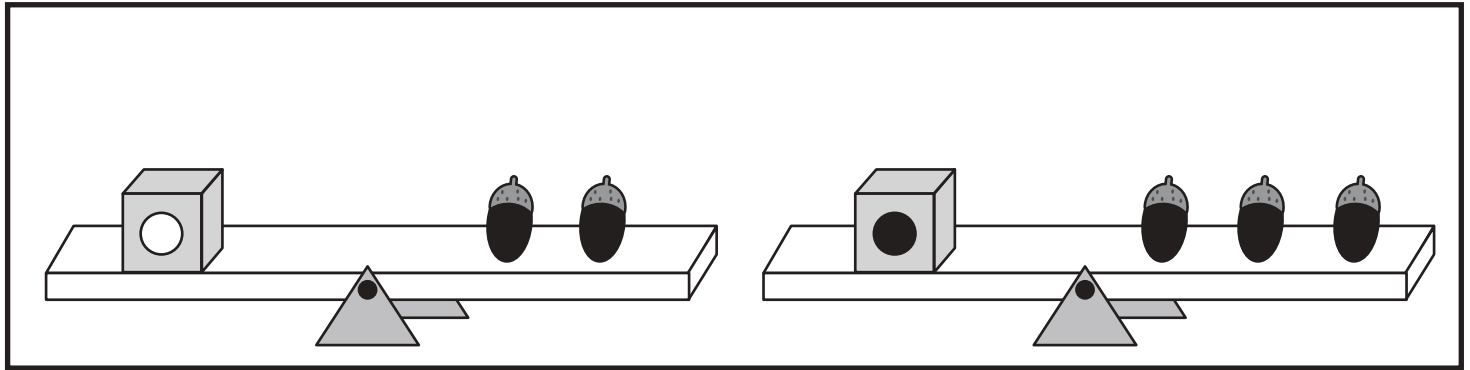

※1. このプリントは、しながわ・目黒こどもスクールのウェブサイトからダウンロードできます。無断複写・引用はご遠慮ください。

※2. このプリントを活用したオンライン授業のスケジュールは、しながわ・目黒こどもスクールのウェブサイトでご確認ください。



おうちで、やろう。

Study at home. 小学校受験の家庭学習教材

数量：置き換え 11

上の太い四角の中がお約束です。記号のついた箱はいくつかのドングリと同じ重さで吊り合っています。下のシーソーが釣り合うためには右側にあといくつのドングリを乗せればよいかを考えて、その数だけ矢印の右の四角に○をかきます。

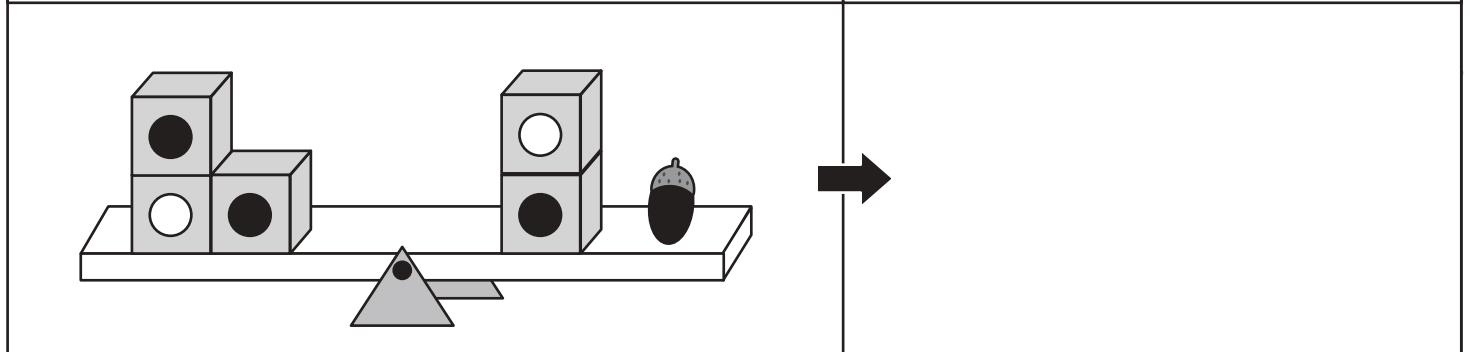
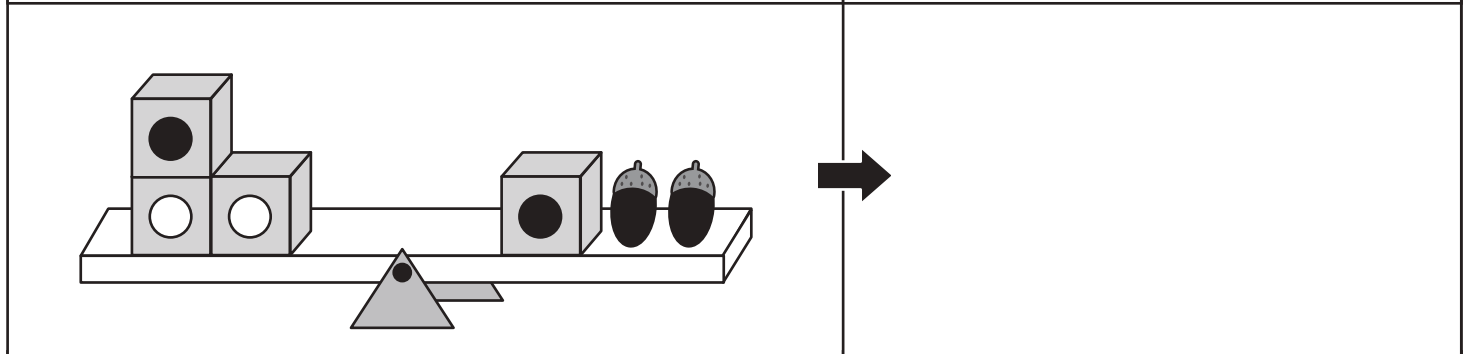
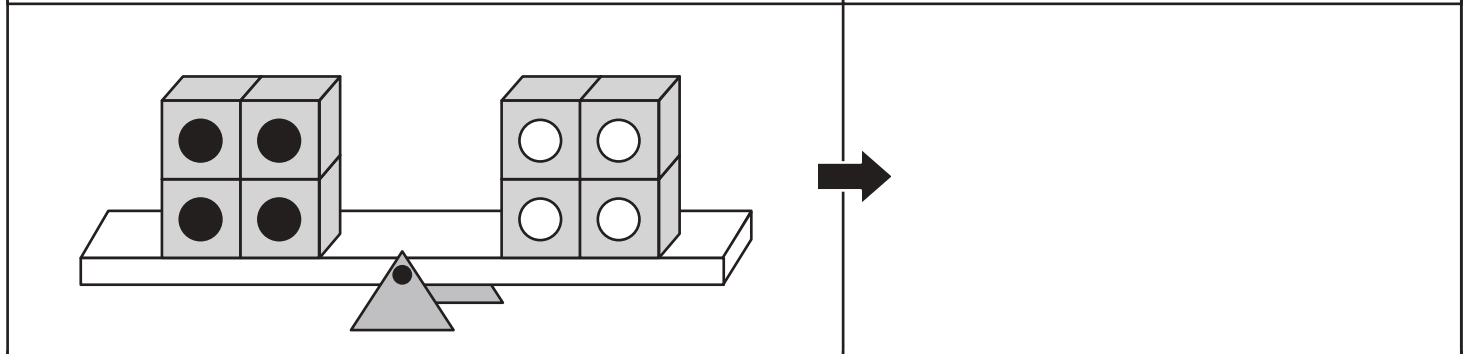
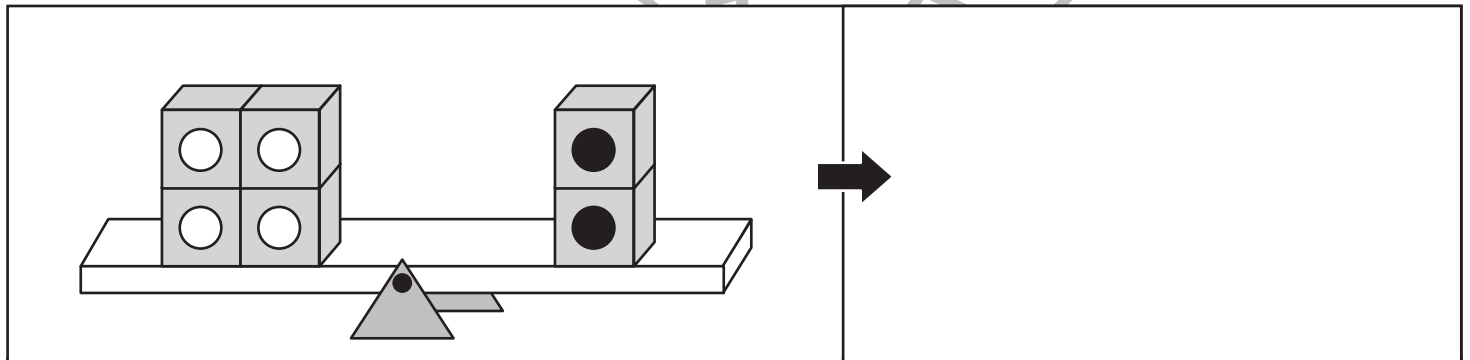
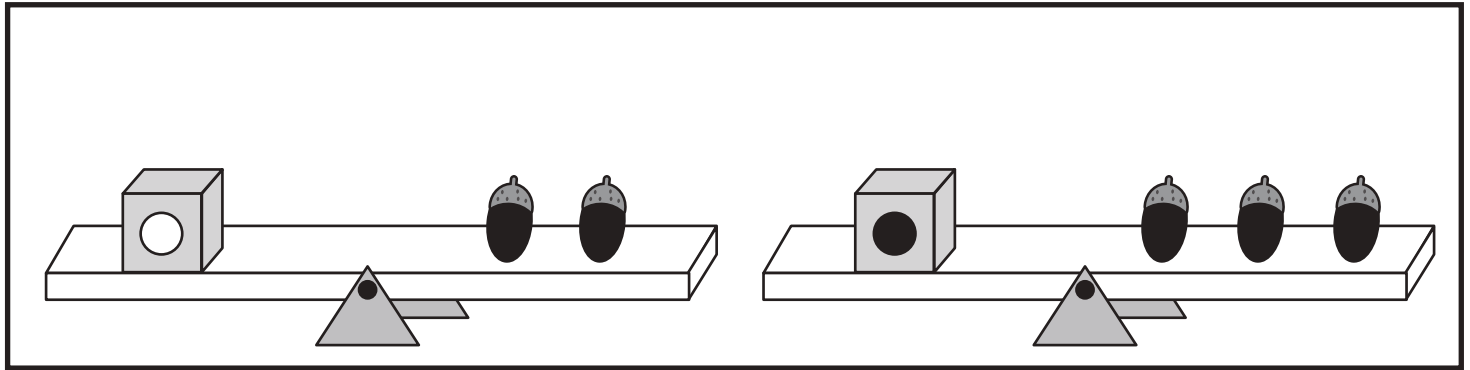

※1. このプリントは、しながわ・目黒こどもスクールのウェブサイトでダウンロードができます。無断複写・引用はご遠慮ください。

※2. このプリントを活用したオンライン授業のスケジュールは、しながわ・目黒こどもスクールのウェブサイトでご確認ください。





おうちで、やろう。

Study at home. 小学校受験の家庭学習教材

数量：計数 14

- ①丸の中にあるリンゴの数だけ○をかきます。
- ②四角の中にあるミカンの数だけ○をかきます。
- ③丸と四角が重なっている場所にあるリンゴの数だけ○をかきます。
- ④丸と四角の外にあるミカンの数だけ○をかきます。

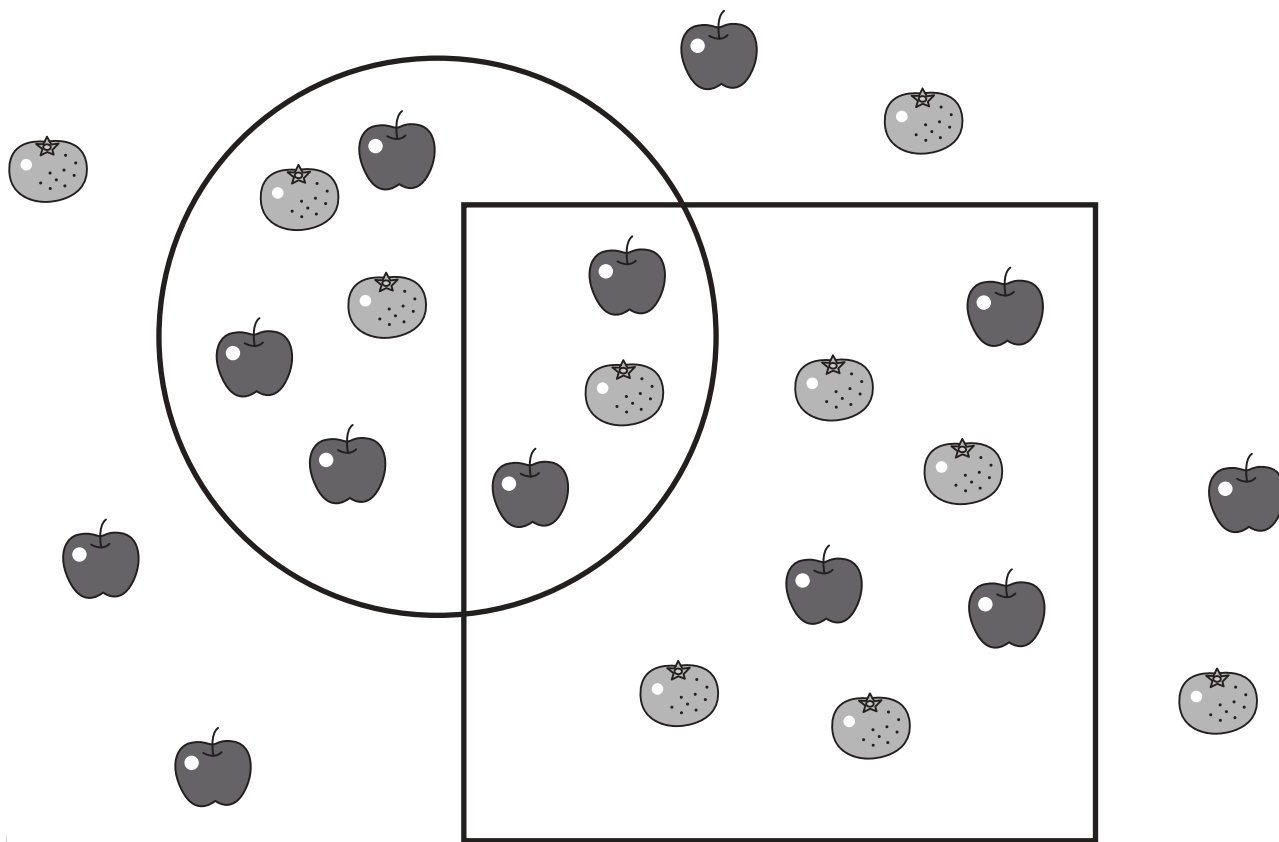

①

②

③

④

※1. このプリントは、しながわ・目黒こどもスクールのウェブサイトでダウンロードができます。無断複写・引用はご遠慮ください。
 ※2. このプリントを活用したオンライン授業のスケジュールは、しながわ・目黒こどもスクールのウェブサイトでご確認ください。



おうちで、やろう。

Study at home. 小学校受験の家庭学習教材

数量：計数 15

- ①丸の中にあるミカンの数だけ○をかきます。
- ②四角の中にあるリンゴの数だけ○をかきます。
- ③丸と四角が重なっている場所にあるミカンの数だけ○をかきます。
- ④丸と四角の外にあるリンゴの数だけ○をかきます。

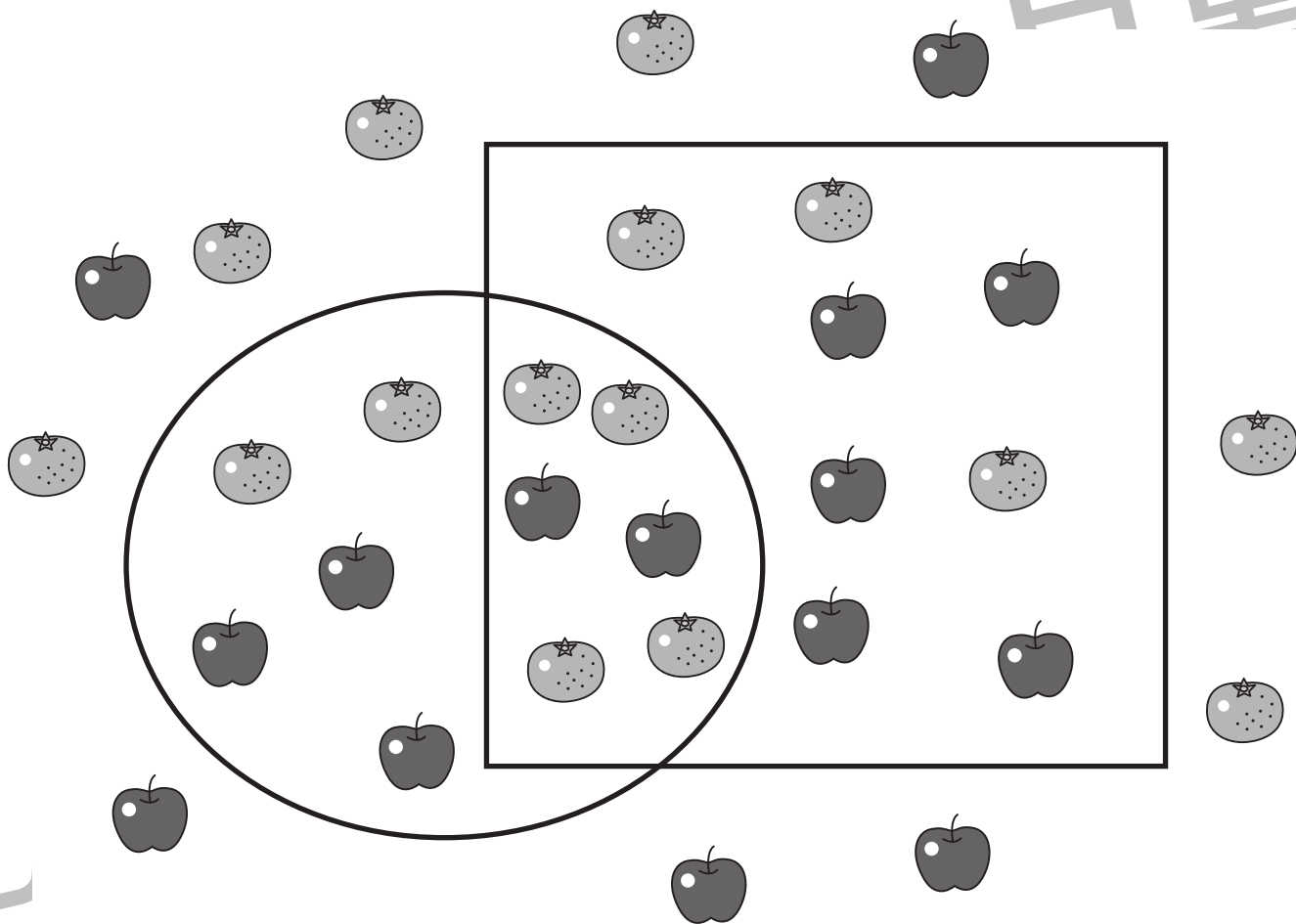

①

②

③

④

※1. このプリントは、しながわ・目黒こどもスクールのウェブサイトでダウンロードができます。無断複写・引用はご遠慮ください。
 ※2. このプリントを活用したオンライン授業のスケジュールは、しながわ・目黒こどもスクールのウェブサイトでご確認ください。



おうちで、やろう。

Study at home. 小学校受験の家庭学習教材

数量：計数 16

- ①丸と四角の中にあるリンゴの数だけ○をかきます。
- ②丸の外にあるミカンの数だけ○をかきます。
- ③丸と四角の外にあるリンゴはあといくつあれば 10 になりますか。足りない数だけ○をかきます。
- ④丸の中にあるミカンの数と四角の中にあるミカンの数の違いはいくつですか。その数だけ○をかきます。

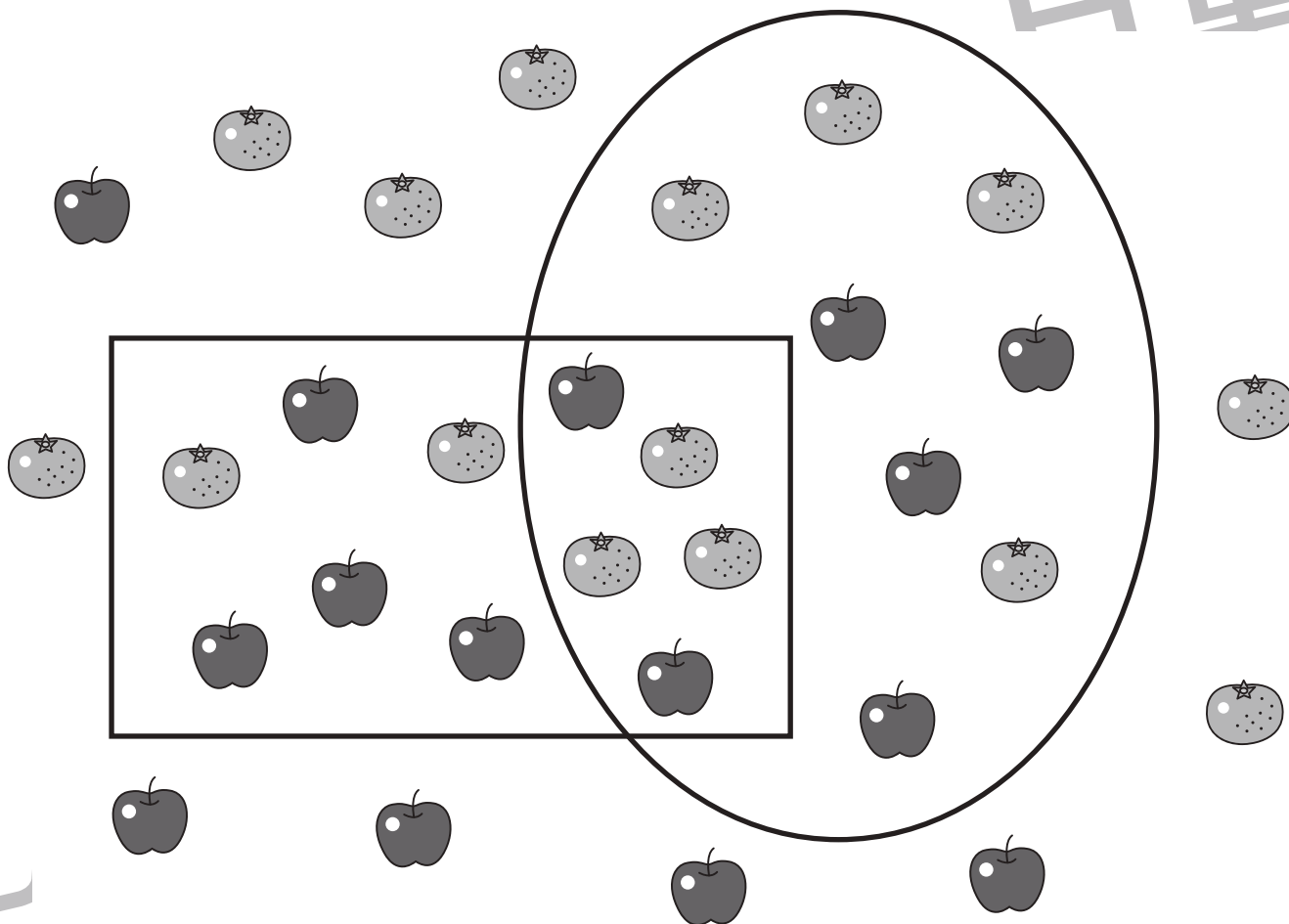

- ①
- ②
- ③
- ④

※ 1. このプリントは、しながわ・目黒こどもスクールのウェブサイトでダウンロードができます。無断複写・引用はご遠慮ください。
 ※ 2. このプリントを活用したオンライン授業のスケジュールは、しながわ・目黒こどもスクールのウェブサイトでご確認ください。



おうちで、やろう。

Study at home. 小学校受験の家庭学習教材

図形：点図形 35

左のお手本と同じになるように右の四角に線をかきます。 ※このプリントに解答はありません。

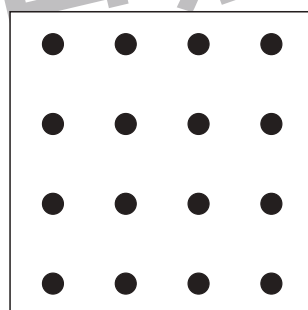
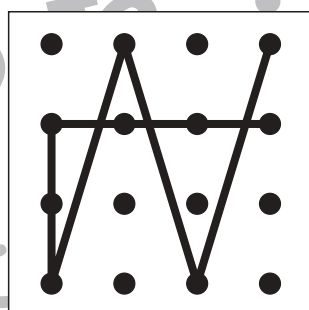
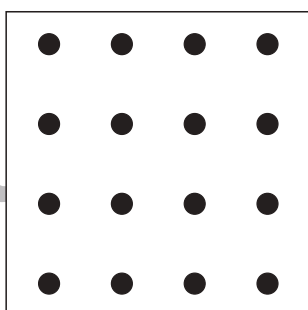
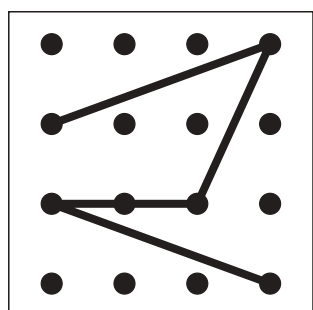
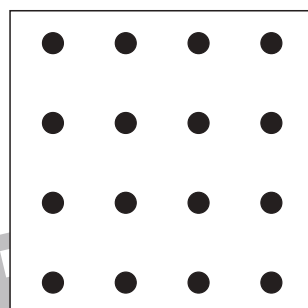
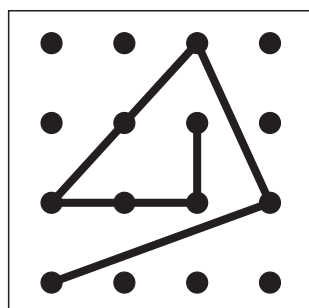
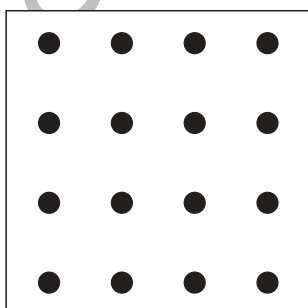
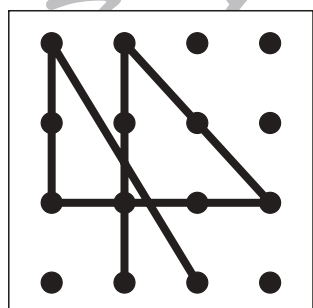
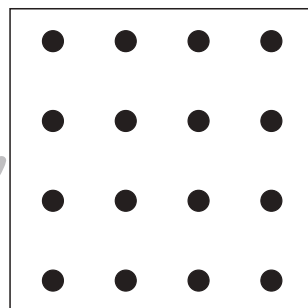
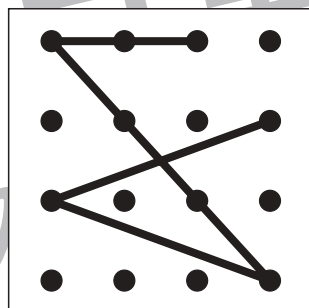
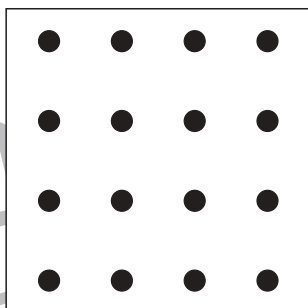
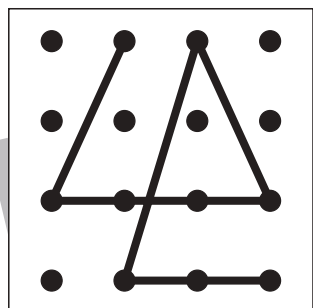
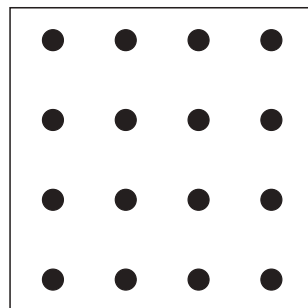
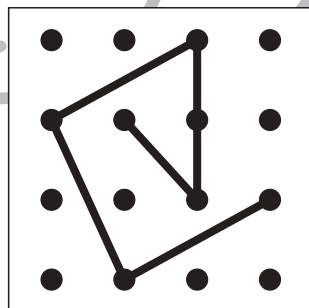
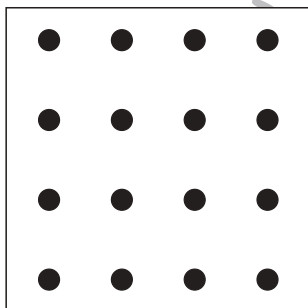
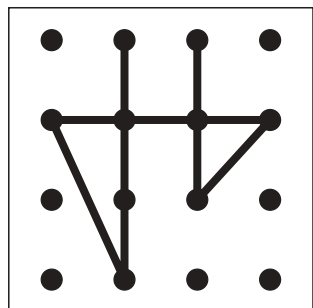
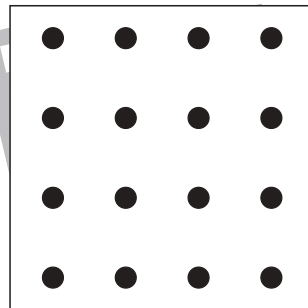
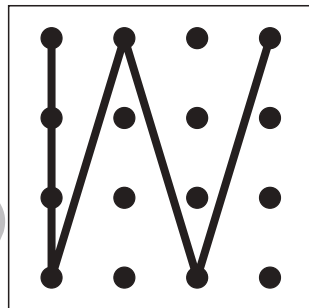
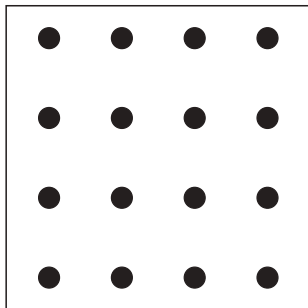
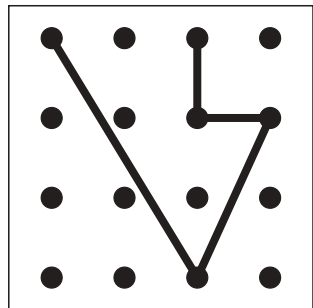

※1. このプリントは、しながわ・目黒こどもスクールのウェブサイトでダウンロードができます。無断複写・引用はご遠慮ください。
※2. このプリントを活用したオンライン授業のスケジュールは、しながわ・目黒こどもスクールのウェブサイトでご確認ください。

